



RURO Gereedschappen B.V.

vestingdok 4
3433KR Nieuwegein
www.ruro.nl
030-6084242



CATALOGUS 2025

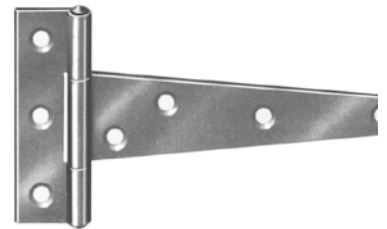

CE



CE



PLANKENDRAGERS

Plankendrager geperste uitvoering

Code 29

Art. Nr.	Afm. A	Afm. B	Afm. C	Kleur	belastbaar	VE	MBH	Prijs €
000150100LW	100 mm	125 mm	32 mm	Wit	30 kg	20	20	0,49
000150125LW	125 mm	150 mm	32 mm	Wit	25 kg	20	20	0,58
000150150LW	150 mm	200 mm	37 mm	Wit	30 kg	20	20	0,78
000150200LW	200 mm	250 mm	40 mm	Wit	30 kg	20	20	1,16
000150250LW	250 mm	300 mm	44 mm	Wit	35 kg	20	20	1,68
000150300LW	300 mm	350 mm	44 mm	Wit	40 kg	20	20	2,15
000150100LS	100 mm	125 mm	32 mm	Zwart	30 kg	20	20	0,53
000150125LS	125 mm	150 mm	31 mm	Zwart	25 kg	20	20	0,62
000150150LS	150 mm	200 mm	35 mm	Zwart	30 kg	20	20	0,84
000150200LS	200 mm	250 mm	40 mm	Zwart	30 kg	20	20	1,24
000150250LS	200 mm	300 mm	45 mm	Zwart	35 kg	20	20	1,80
000150300LS	300 mm	350 mm	50 mm	Zwart	40 kg	20	20	2,29

Plankendrager aluminium

Code 29

Art. Nr.	Afm. A	Afm. B	Afm. C	Kleur	belastbaar	VE	MBH	Prijs €
050155100W	100 mm	150 mm	20 mm	Wit	75 kg	10	10	2,35
050155150W	150 mm	200 mm	20 mm	Wit	55 kg	10	10	3,25
050155200W	200 mm	250 mm	26 mm	Wit	70 kg	10	10	4,82
050155250W	250 mm	300 mm	26 mm	Wit	95 kg	10	10	6,30

Code 29

Art. Nr.	Afm. A	Afm. B	Afm. C	Kleur	belastbaar	VE	MBH	Prijs €
050155100S	100 mm	150 mm	20 mm	Zwart	75 kg	10	10	2,39
050155150S	150 mm	200 mm	20 mm	Zwart	55 kg	10	10	3,19
050155200S	200 mm	250 mm	26 mm	Zwart	70 kg	10	10	4,65
050155250S	250 mm	300 mm	26 mm	Zwart	95 kg	10	10	5,83

Plankendrager Delta Line



Code 29

Art. Nr.	Afm. A	Afm. B	Afm. C	Kleur	belastbaar	VE	MBH	Prijs €
000146200W	200 mm	200 mm	24 mm	Wit	95 kg	4	4	4,65
000146300W	300 mm	300 mm	24,5 mm	Wit	95 kg	4	4	8,77
000146200S	200 mm	200 mm	24 mm	Zwart	95 kg	4	4	4,65
000146300S	300 mm	300 mm	24,5 mm	Zwart	95 kg	4	4	8,77



PLANKENDRAGERS

F3 Plankendrager



Code 29

Art. Nr.	Afm. A	Afm. B	Afm. C	Kleur	belastbaar	VE	MBH	Prijs €
000165115W	115 mm	80 mm	40 mm	Wit	20 kg	10	10	2,02
000165160W	160 mm	105 mm	40 mm	Wit	25 kg	10	10	2,60
000165235W	235 mm	160 mm	40 mm	Wit	25 kg	10	10	3,84
000165315W	315 mm	200 mm	40 mm	Wit	30 kg	10	10	4,99
000165115S	115 mm	80 mm	40 mm	Zwart	20 kg	10	10	2,05
000165160S	160 mm	105 mm	40 mm	Zwart	25 kg	10	10	2,65
000165235S	235 mm	160 mm	40 mm	Zwart	25 kg	10	10	3,91
000165315S	315 mm	200 mm	40 mm	Zwart	30 kg	6	6	5,07
000165115SM	115 mm	80 mm	40 mm	Staal mat	20 kg	10	10	2,30
000165160SM	160 mm	105 mm	40 mm	Staal mat	25 kg	10	10	3,15
000165235SM	235 mm	160 mm	40 mm	Staal mat	25 kg	10	10	5,01



Plankendrager voor schappen

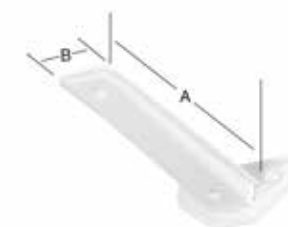

Code 29

Art. Nr.	Afm. A	Afm. B	Afm. C	Kleur	belastbaar	VE	MBH	Prijs €
000166190W	190 mm	38 mm		Wit	65 kg	4	4	3,21
000166190S	190 mm	38 mm		Zwart	65 kg	6	6	3,21
000166190SM	190 mm	38 mm		Staal mat	65 kg	4	4	4,73

PLANKENDRAGERS

Industriedrager



Code 29

Art. Nr.	Afm. A	Afm. B	Afm. C	Kleur	Belastbaar	VE	MBH	Prijs €
000159250W	250 mm	150 mm	30 mm	Wit	100 kg	10	10	4,85
000159300W	300 mm	200 mm	30 mm	Wit	150 kg	10	10	5,51
000159400W	400 mm	250 mm	30 mm	Wit	150 kg	10	10	6,93
000159500W	500 mm	330 mm	30 mm	Wit	150 kg	10	10	8,32

Code 29

Art. Nr.	Afm. A	Afm. B	Afm. C	Kleur	Belastbaar	VE	MBH	Prijs €
000159300S	300 mm	200 mm	30 mm	Zwart	150 kg	10	10	5,51
000159400S	400 mm	250 mm	30 mm	Zwart	150 kg	10	10	7,06
000159500S	500 mm	330 mm	30 mm	Zwart	150 kg	10	10	8,28

Code 29

Art. Nr.	Afm. A	Afm. B	Afm. C	Kleur	Belastbaar	VE	MBH	Prijs €
000159250Z	250 mm	150 mm	30 mm	Verzinkt	100 kg	10	10	4,89
000159300Z	300 mm	200 mm	30 mm	Verzinkt	150 kg	10	10	6,18
000159400Z	400 mm	250 mm	30 mm	Verzinkt	150 kg	10	10	7,35
000159500Z	500 mm	330 mm	30 mm	Verzinkt	150 kg	10	10	9,03



PLANKENDRAGERS

Plankendrager Multi line



Code 29

Art. Nr.	Afm. A	Afm. B	Afm. C	Kleur	belastbaar	VE	MBH	Prijs €
000152300Z	300 mm	200 mm	30 mm	Verzinkt	60 kg	2	2	13,22
000152400Z	400 mm	270 mm	36 mm	Verzinkt	60 kg	2	2	17,86
010152300	300 mm	200 mm	30 mm	RVS V4A	100 kg	2	2	50,69
010152400	400 mm	270 mm	36 mm	RVS V4A	150 kg	2	2	69,06
000152400WA	400 mm	270 mm	36 mm	Staal	60 kg	2	2	18,11
000152300W	300 mm	200 mm	30 mm	Wit	60 kg	2	2	10,62
000152400W	400 mm	270 mm	36 mm	Wit	60 kg	2	2	18,08



EDELSTAHL
Rost
frei
STAINLESS STEEL
V4A - RVS 316



Klapdrager

Code 29

Art. Nr.	Afm. A	Afm. B	Afm. C	Kleur	belstbaar	VE	MBH	Prijs €
000143200Z	180 mm	60 mm	47 mm	Verzinkt	75 kg	2	2	4,42
000143300Z	300 mm	60 mm	47 mm	Verzinkt	50 kg	2	2	5,57

Code 29

Art. Nr.	Afm. A	Afm. B	Afm. C	Kleur	belstbaar	VE	MBH	Prijs €
000143200W	180 mm	60 mm	47 mm	Wit	75 kg	2	2	5,15
000143300W	300 mm	60 mm	47 mm	Wit	50 kg	2	2	6,27



L-Drager

Code 29

Art. Nr.	Afm. A	Afm. B	Afm. C	Kleur	belastbaar	VE	MBH	Prijs €
000154175Z	175 mm	70 mm	37 mm	Verzinkt	75 kg	5	5	5,46
000154240Z	240 mm	80 mm	46 mm	Verzinkt	75 kg	5	5	7,52
000154280Z	280 mm	100 mm	53 mm	Verzinkt	75 kg	5	5	9,52
000154330Z	330 mm	100 mm	53 mm	Verzinkt	75 kg	5	5	10,40
000154380Z	380 mm	130 mm	65 mm	Verzinkt	75 kg	5	5	15,95
000154480Z	480 mm	130 mm	65 mm	Verzinkt	75 kg	5	5	18,39
000154580Z	580 mm	170 mm	80 mm	Verzinkt	75 kg	5	5	27,59
000154680Z	680 mm	170 mm	81 mm	Verzinkt	75 kg	5	5	31,61



WANDRAILS



Wandrail staal, enkel

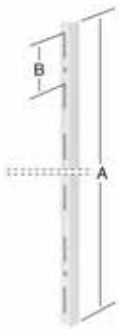

Code 29

Art. Nr.	Afm. A	Afm. B	Afm. C	Kleur	belastbaar	VE	MBH	Prijs €
062102050W	500 mm	50 mm		Wit		20	20	2,28
062102100W	1000 mm	50 mm		Wit		20	20	4,06
062102150W	1500 mm	50 mm		Wit		20	20	6,34
062102200W	2000 mm	50 mm		Wit		20	20	8,45

Wandrail staal, dubbel 32mm

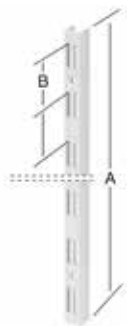

Code 29

Art. Nr.	Afm. A	Afm. B	Afm. C	Kleur	belastbaar	VE	MBH	Prijs €
062104100W	1000 mm	50 mm		Wit		20	20	5,05
062104150W	1500 mm	50 mm		Wit		20	20	7,89
062104200W	2000 mm	50 mm		Wit		20	20	10,53

WANDRAILS

Drager staal, enkel

Code 29

Art. Nr.	Afm. A	Afm. B	Afm. C	Kleur	belastbaar	VE	MBH	Prijs €
062501150W	150 mm	50 mm		Wit	60 kg	20	20	0,76
062501200W	200 mm	50 mm		Wit	60 kg	20	20	0,92
062501250W	250 mm	50 mm		Wit	60 kg	20	20	1,35
062501300W	300 mm	50 mm		Wit	60 kg	20	20	1,58
062501350W	350 mm	50 mm		Wit	60 kg	20	20	1,85
062501400W	400 mm	50 mm		Wit	60 kg	20	20	2,11
062502500W	500 mm	50 mm		Wit	60 kg	20	20	4,82
062502600W	600 mm	50 mm		Wit	60 kg	20	20	5,94



Drager staal, dubbel

Code 29

Art. Nr.	Afm. A	Afm. B	Afm. C	Kleur	belastbaar	VE	MBH	Prijs €
062506170W	170 mm	50 mm		Wit	50 kg	20	20	1,12
062506220W	220 mm	50 mm		Wit	50 kg	20	20	1,68
062506270W	270 mm	50 mm		Wit	50 kg	20	20	2,18
062506370W	370 mm	50 mm		Wit	50 kg	20	20	2,77
062506470W	470 mm	50 mm		Wit	50 kg	20	20	4,36



Drager staal, Enkel gehoekt

Code 29

Art. Nr.	Afm. A	Afm. B	Afm. C	Kleur	belastbaar	VE	MBH	Prijs €
062504480W	480 mm	50 mm		Wit	55 kg	10	10	11,02
062504480WA	480 mm	50 mm		Staal	55 kg	10	10	11,02



MONTAGEBAND

Montage band met doorlopend gaten patroon

Code 29



Art. Nr.	Afmeting	Lengte	Materiaal	VE	MBH	Prijs €
001401012ZF	12x0,9 mm	3 m	Verzinkt	10	10	4,72
001401016ZF	16x0,9 mm	3 m	Verzinkt	10	10	5,23
001401020ZF	20x1,0 mm	3 m	Verzinkt	10	10	6,77
001403012ZF	12x0,9 mm	10 m	Verzinkt	5	5	9,72
001403016ZF	16x0,9 mm	10 m	Verzinkt	5	5	11,83
001403020ZF	20x1,0 mm	10 m	Verzinkt	5	5	14,67

Code 29



Art. Nr.	Afmeting	Lengte	Materiaal	VE	MBH	Prijs €
011401016	16x0,9 mm	3 m	RVS V2A	5	5	12,26
011403016	16x0,9 mm	10 m	RVS V2A	1	1	28,04

MUURHAKEN

Muurhaak RVS 52x55 mm

Code 29



Art. Nr.	Afm. A	Afm. B	Afm. C	Kleur	belastbaar	VE	MBH	Prijs €
010290001	52 mm	55 mm	4,8 mm	RVS V2A	20 kg	10	10	7,64

Muurhaak RVS 120x55 mm

Code 29



Art. Nr.	Afm. A	Afm. B	Afm. C	Kleur	belastbaar	VE	MBH	Prijs €
010290002	120 mm	55 mm	4,8 mm	RVS V2A	20 kg	10	10	7,87

Ladder- en gereedschap houder

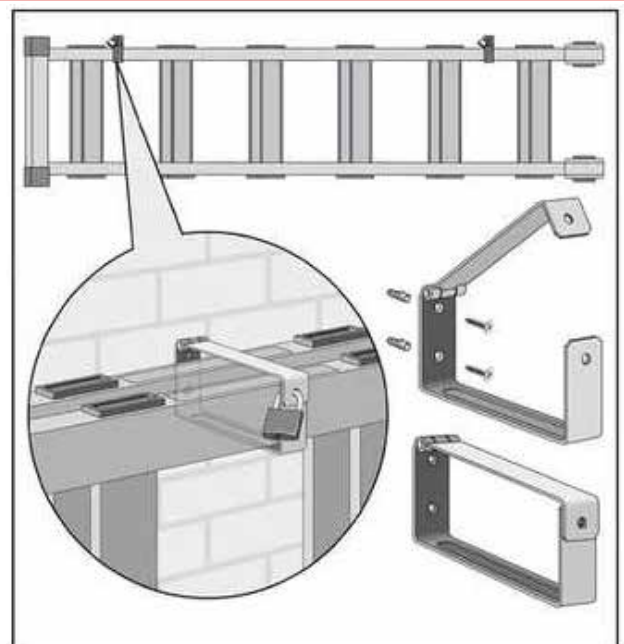

Code 29

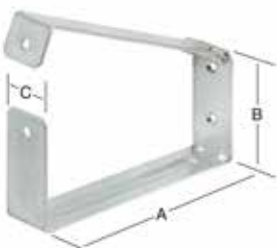

Art. Nr.	Afm. A	Afm. B	Afm. C	Kleur	belastbaar	VE	MBH	Prijs €
001440200Z	200 mm	90 mm	40 mm	Verzinkt		2	2	16,15

POS AFGESTEMD OP UW WENSEN

De informatieve pictogrammen boven de presentaties zijn verdere middelen op het POS om de klant met succes aan te spreken en hem, indien nodig, gebruiksvoorbeelden te geven. Naargelang van het produktassortiment ontvangen onze klanten brochures, waarvan sommige ook geïllustreerd zijn en die meestal alle produkten van het gamma bevatten. VORMANN probeert het vaak zonder (veel) woorden te doen, enerzijds om de klant niet te overladen met vaak overbodige informatie en anderzijds zodat de flyers geschikt zijn voor internationaal gebruik.

Goederen om aan te raken

Als het passend is en in de presentatie kan worden geïntegreerd, kunnen ook toepassingsmodellen en monsters worden bijgevoegd, die de klant eveneens aanspreken en de aankoopbeslissing vergemakkelijken.

Presentatie van goederen in de CI van de klant

Tot ons POS-concept behoort ook het op verzoek leveren van goederen in klantspecifieke "eigen presentatie", Neem contact met ons op en laat ons u een concept voorstellen!



MUURHAKEN

Muurhaak U-Vorm, verzinkt staal

Code 29

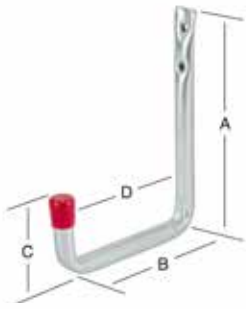

Art. Nr.	Afm. A	Afm. B	Afm. C	Kleur	belastbaar	VE	MBH	Prijs €
001450002Z	120 mm	82 mm	41 mm	Verzinkt	35 kg	5	5	1,51
001450004Z	140 mm	114 mm	53 mm	Verzinkt	25 kg	5	5	1,71
001450006Z	213 mm	150 mm	85 mm	Verzinkt	37 kg	5	5	2,75
001450008Z	302 mm	250 mm	91 mm	Verzinkt	22 kg	5	5	3,62

Muurhaak verzinkt met rode rubbercoating

Code 29

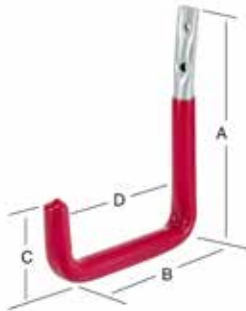

Art. Nr.	Afm. A	Afm. B	Afm. C	Kleur	belastbaar	VE	MBH	Prijs €
001451004BL	140 mm	114 mm	53 mm	Verzinkt	25 kg	5	5	3,45
001451006BL	213 mm	150 mm	85 mm	Verzinkt	37 kg	5	5	4,22
001451008BL	302 mm	250 mm	91 mm	Verzinkt	22 kg	5	5	5,76

Verzinkt staal plafondhaak

Code 29



Art. Nr.	Afm. A	Afm. B	Afm. C	Kleur	belastbaar	VE	MBH	Prijs €
001453004Z	255 mm	148 mm	72 mm	Verzinkt	20 kg	5	5	4,62

Muurhaak blank verzinkt staal met kunststof bekleding

Code 29

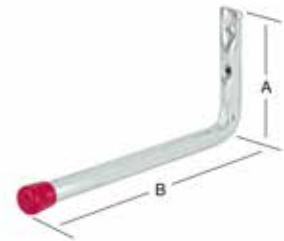

Art. Nr.	Afmetingen	Materiaal	Uitvoering	VE	MBH	Prijs €
001454002Z	78x175 mm	Verzinkt staal	Kunststof	5	5	1,74

Dubbele muurhaak blank verzinkt staal met kunststof bekleding

Code 29

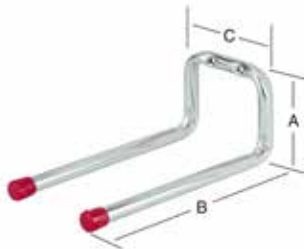

Art. Nr.	Afmetingen	Materiaal	Uitvoering	VE	MBH	Prijs €
001455002Z	78x195 mm	Verzinkt staal	Kunststof	5	5	3,08

Dubbele muurhaak van verzinkt staal met kunststof bekleding

Code 29

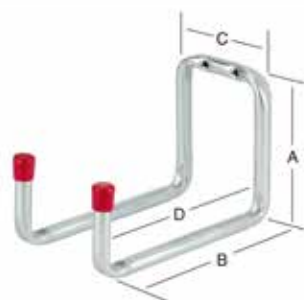

Art. Nr.	Afmetingen	Materiaal	VE	MBH	Prijs €
001471004Z	120X175X90	Verzinkt staal	5	5	3,52
001471006Z	120X250X90	Verzinkt staal	5	5	4,05
001471008Z	120X325X90	Verzinkt staal	5	5	4,66

MUURHAKEN

Muurhaak 245x230x150x125 mm verzinkt staal

Code 29

Art. Nr.	Afm. A	Afm. B	Afm. C	Afm. D	Kleur	belastbaar	VE	MBH	Prijs €
001464001Z	150 mm	245 mm	230 mm	125 mm	Verzinkt	72 kg	5	5	7,24

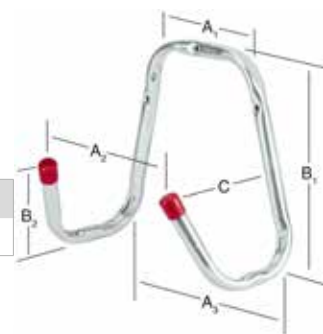

S-haak 175x65x52 mm verzinkt staal

Code 29

Art. Nr.	Afm. A	Afm. B	Afm. C	Kleur	belastbaar	VE	MBH	Prijs €
001469001Z	175 mm	65 mm	52 mm	Verzinkt	27 kg	5	5	1,54

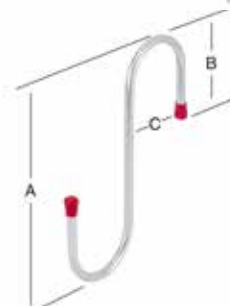

Hekvergrendelhouder 160x37x30 mm verzinkt staal

Code 29

Art. Nr.	Afm. A	Afm. B	Afm. C	Kleur	VE	MBH	Prijs €
001478000Z	160 mm	37 mm	30 mm	Verzinkt	20	20	4,29

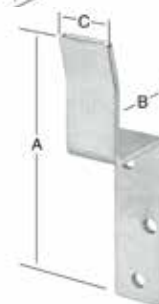

Ophanghaak verzinkt

Code 29

Art. Nr.	Afm. A	Afm. B	Afm. C	Afm. D	Kleur	belastbaar	VE	MBH	Prijs €
001456002Z	87 mm	32 mm	39 mm	15 mm	Verzinkt	17 kg	5	5	0,94
001460004Z	110 mm	55 mm	60 mm	20 mm	Verzinkt	37 kg	5	5	2,14
001460006Z	173 mm	106 mm	82 mm	25 mm	Verzinkt	35 kg	5	5	3,72

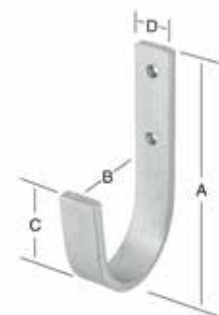

Garderobehaak

Code 29

Art. Nr.	Afm. A1	Afm. A2	Afm. B1	Afm. B2	Kleur	gaten	VE	MBH	Prijs €
000280001Z	49 mm	36 mm	15 mm	17 mm	Verzinkt	2	10	10	0,77
000280002Z	65 mm	87 mm	35 mm	17 mm	Verzinkt	2	10	10	1,21
000280001W	49 mm	36 mm	15 mm	17 mm	Wit	2	10	10	0,90
000280002W	65 mm	87 mm	35 mm	17 mm	Wit	2	10	10	1,68

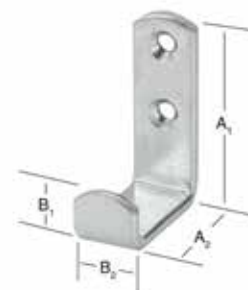

Sluitplaat voor luiken

Code 29

Art. Nr.	Afmetingen	Materiaal	VE	MBH	Prijs €
010255000	74x32x1,2mm	RVS	50	50	0,90



TRAPLEUNING HOUDERS

Leuninghouder 90 graden, vast met vlake bevestigingsplaat

Code 29



Art. Nr.	Afm. A	Afm. B	Kleur	gaten	VE	MBH	Prijs €
000350001Z	63 mm	65 mm	Verzinkt	3/2	10	10	4,29
000350001W	63 mm	65 mm	Verzinkt	3/2	10	10	4,46
000350001S	63 mm	65 mm	Zwart	3/2	10	10	4,46



Leuninghouder 90 graden, verstelbaar met afdekrozet en gevormde bevestigingsplaat

Code 29



Art. Nr.	Afm. A	Kleur	gaten	VE	MBH	Prijs €
006010090RF	75 mm	RVS V2A	3/2	8	8	14,30



Leuninghouder 90 graden, vast met afdekrozet en gevormde bevestigingsplaat

Code 29



Art. Nr.	Afm. A	Kleur	gaten	VE	MBH	Prijs €
006011090RF	75 mm	RVS-V2A	3/2	8	8	12,83
006011090S	75 mm	Zwart	3/2	8	8	6,87

Versterkingshoek

Code 29



Art. Nr.	Afm. A	Afm. B	Kleur	dikte	gaten	prijs per	VE	MBH	Prijs €
000177030Z	30 mm	30 mm	Verzinkt	2,0 mm	4	1	50	50	0,30
000177030ZP	30 mm	30 mm	Verzinkt	2,0 mm	4	12	6	6	3,21
000177040Z	40 mm	40 mm	Verzinkt	2,0 mm	4	1	50	50	0,42
000177040ZP	40 mm	40 mm	Verzinkt	2,0 mm	4	12	4	4	4,92
000177050Z	50 mm	50 mm	Verzinkt	2,0 mm	4	1	50	50	0,66
000177060Z	60 mm	60 mm	Verzinkt	2,0 mm	4	1	20	20	0,90



000177030S	30 mm	30 mm	Zwart	2,0 mm	4	1	50	50	0,45
000177040S	40 mm	40 mm	Zwart	2,0 mm	4	1	50	50	0,67
000177050S	50 mm	50 mm	Zwart	2,0 mm	4	1	50	50	0,93
000177060S	60 mm	60 mm	Zwart	2,0 mm	4	1	20	20	1,34



000177030W	30 mm	30 mm	Wit	2,0 mm	4	1	50	50	0,45
000177040W	40 mm	40 mm	Wit	2,0 mm	4	1	50	50	0,67
000177060W	60 mm	60 mm	Wit	2,0 mm	4	1	20	20	1,34
010177030	30 mm	30 mm	RVS-V2A	2,0 mm	4	1	20	20	0,74
010177040	40 mm	40 mm	RVS-V2A	2,0 mm	4	1	20	20	1,28

HOEKEN

Stoelhoek

Code 29

Art. Nr.	Afm. A	Afm. B	Kleur	Dikte	gaten	VE	MBH	Prijs €
000180025Z	25 mm	15 mm	Verzinkt	2,0 mm	4	100	100	0,16
000180025ZP	25 mm	15 mm	Verzinkt	2,0 mm	4	10	10	1,61
000180030Z	30 mm	15 mm	Verzinkt	2,0 mm	4	100	100	0,19
000180030ZP	30 mm	15 mm	Verzinkt	2,0 mm	4	10	10	1,98
000180040Z	40 mm	15 mm	Verzinkt	2,0 mm	4	100	100	0,19
000180040ZP	40 mm	15 mm	Verzinkt	2,0 mm	4	10	10	2,11
000180050Z	50 mm	15 mm	Verzinkt	2,0 mm	4	100	100	0,25
000180050ZP	50 mm	15 mm	Verzinkt	2,0 mm	4	10	10	2,68
000180060Z	60 mm	18 mm	Verzinkt	2,0 mm	4	100	100	0,32
000180060ZP	60 mm	18 mm	Verzinkt	2,0 mm	4	10	10	2,30
000180080Z	80 mm	18 mm	Verzinkt	2,0 mm	4	50	50	0,41
000180080ZP	80 mm	18 mm	Verzinkt	2,0 mm	4	10	10	2,90
000180100Z	100 mm	20 mm	Verzinkt	2,0 mm	6	50	50	0,54
000180120Z	120 mm	20 mm	Verzinkt	2,0 mm	6	50	50	0,72
000181125Z	125 mm	22 mm	Verzinkt	3,0 mm	6	20	20	0,91
000181150Z	150 mm	25 mm	Verzinkt	3,0 mm	6	20	20	1,45
000180025S	25 mm	15 mm	Zwart	2,0 mm	4	100	100	0,28
000180040S	40 mm	15 mm	Zwart	2,0 mm	4	100	100	0,35
000180050S	50 mm	15 mm	Zwart	2,0 mm	4	50	50	0,66
000180060S	60 mm	18 mm	Zwart	2,0 mm	4	50	50	0,76
000180080S	80 mm	18 mm	Zwart	2,0 mm	4	50	50	0,88
000180025W	25 mm	15 mm	Wit	2,0 mm	4	100	100	0,28
000180040W	40 mm	15 mm	Wit	2,0 mm	4	100	100	0,35
000180050W	50 mm	15 mm	Wit	2,0 mm	4	50	50	0,66
000180060W	60 mm	18 mm	Wit	2,0 mm	4	50	50	0,76
000180080W	80 mm	18 mm	Wit	2,0 mm	4	50	50	0,88
010180025	25 mm	15 mm	RVS-V2A	2,0 mm	4	50	50	0,35
010180040	40 mm	15 mm	RVS-V2A	2,0 mm	4	50	50	0,50
010180050	50 mm	15 mm	RVS-V2A	2,0 mm	4	50	50	0,72
010180060	60 mm	18 mm	RVS-V2A	2,0 mm	4	50	50	0,95
010180080	80 mm	18 mm	RVS-V2A	2,0 mm	4	50	50	1,20
010180100	100 mm	20 mm	RVS-V2A	2,0 mm	6	50	50	1,80



HOEKEN

Drempelhoek zware uitvoering

Code 29



Art. Nr.	Afm. A	Afm. B	Kleur	dikte	gaten	VE	MBH	Prijs €
000182100Z	100 mm	20 mm	Verzinkt	5,0 mm	4	10	10	1,29
000182120Z	120 mm	20 mm	Verzinkt	5,0 mm	4	10	10	1,54
000182140Z	140 mm	20 mm	Verzinkt	5,0 mm	4	10	10	1,80
000182160Z	160 mm	20 mm	Verzinkt	5,0 mm	6	10	10	1,95
000182180Z	180 mm	20 mm	Verzinkt	5,0 mm	6	10	10	2,21



Bredehoek verzinkt

Code 29

Art. Nr.	Afm. A	Afm. B1	Afm. B2	Kleur	dikte	gaten	VE	MBH	Prijs €
000172075Z	75 mm	40 mm	25 mm	Verzinkt	2,0 mm	5	20	20	0,66
000172115Z	115 mm	60 mm	40 mm	Verzinkt	2,5 mm	8	20	20	1,76

Balkenhoek zwaar

Code 29



Art. Nr.	Afm. A	Afm. A2	Afm. B	Kleur	dikte	gaten	VE	MBH	Prijs €
000179080Z	80 mm	40 mm	30 mm	Verzinkt	2,0 mm	5	20	20	0,54
000179100Z	100 mm	75 mm	30 mm	Verzinkt	3,0 mm	5	10	10	1,07
000179120Z	120 mm	80 mm	35 mm	Verzinkt	4,0 mm	9	10	10	1,83
000179180Z	180 mm	120 mm	40 mm	Verzinkt	5,0 mm	7	10	10	3,56
000179240Z	240 mm	160 mm	50 mm	Verzinkt	5,0 mm	10	10	10	5,89
000179080S	80 mm	40 mm	30 mm	Zwart	2,0 mm	5	20	20	0,95
000179100S	100 mm	75 mm	30 mm	Verzinkt	3,0 mm	5	10	10	1,51
000179180S	180 mm	120 mm	40 mm	Verzinkt	5,0 mm	7	10	10	4,47
010179080	80 mm	40 mm	30 mm	RVS-V2A	2,0 mm	5	10	10	1,20
010179100	100 mm	75 mm	30 mm	RVS-V2A	3,0 mm	5	10	10	3,59
000179080W	80 mm	40 mm	30 mm	Wit	2,0 mm	5	20	20	0,95
000179100W	100 mm	75 mm	30 mm	Wit	3,0 mm	5	10	10	1,29
000179120W	120 mm	80 mm	35 mm	Wit	3,0 mm	5	10	10	2,33



Verstelbare winkelhaak 25x30 mm

Code 29



Art. Nr.	Afm. A	Afm. B	Kleur	Dikte	gaten	VE	MBH	Prijs €
000174002Z	25 mm	30 mm	Verzinkt	0,80m	3	6	6	2,43
000165025S	25 mm	30 mm	Zwart	1,0 mm	3	50	50	0,41
000165025W	25 mm	30 mm	wit	1,0 mm	3	25	25	0,41

Verbindingshoek verzinkt staal 39x28x22 mm

Code 29



Art. Nr.	Afm. A	Afm. B	Afm. C	Kleur	Dikte	gaten	VE	MBH	Prijs €
000174001Z	39 mm	28 mm	22 mm	Verzinkt	1,0 mm	2	25	25	0,25
000174001S	39 mm	28 mm	22 mm	Zwart	1,0 mm	2	25	25	0,41
000174001W	39 mm	28 mm	22 mm	wit	1,0 mm	2	25	25	0,41

HOEKEN

Winkelhaak Combi staal zwart

Code 29

Art. Nr.	Afm. A	Afm. B	Afm. C	Kleur	dikte	gaten	VE	MBH	Prijs €
070036000K	40 mm	40 mm	50 mm	zwart	2,3mm	4/8	25	25	2,14
070038000K	60 mm	60 mm	50 mm	zwart	2,3mm	4/8	25	25	2,52
070039000K	80 mm	80 mm	50 mm	zwart	2,3mm	4/10	25	25	2,87
070040000K	100 mm	100 mm	50 mm	zwart	2,3mm	4/10	25	25	3,12



Hoekanker zwart staal 40x25x70 mm

Code 29

Art. Nr.	Afm. A1	Afm. A2	Afm. B	Kleur	dikte	gaten	VE	MBH	Prijs €
000165040S	40 mm	25 mm	70 mm	Zwart	1,5 mm	4	20	20	0,95



Spaanplaatbeugel 40x19 mm verzinkt met 4 gaten

Code 29

Art. Nr.	Afm. A	Afm. B	Kleur	dikte	gaten	VE	MBH	Prijs €
000174005Z	40 mm	19 mm	Verzinkt	1,5 mm	4	25	25	0,35

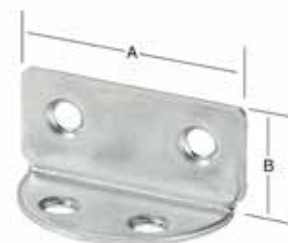

Spaanplaatbeugel 40x19 mm verzinkt met 2 gaten

Code 29

Art. Nr.	Afm. A	Afm. B	Kleur	dikte	gaten	VE	MBH	Prijs €
000174006Z	40 mm	19 mm	Verzinkt	1,5 mm	2	25	25	0,35

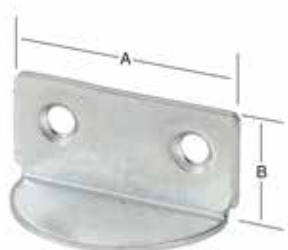

Spaanplaatbeugel verzinkt 40x19x19 mm met 4 gaten

Code 29

Art. Nr.	Afm. A	Afm. B	Kleur	dikte	gaten	VE	MBH	Prijs €
000174010Z	40 mm	19 mm	Verzinkt	1,5 mm	4/1	25	25	0,44



Montageverbindingsplaat met 6 gaten verzinkt

Code 29

Art. Nr.	Afm. A	Afm. B	Afm. C	Kleur	dikte	gaten	VE	MBH	Prijs €
000189075Z	70 mm	36 mm	16 mm	Verzinkt	1,5 mm	6	50	50	0,38
000189125Z	125 mm	54 mm	19 mm	Verzinkt	1,5 mm	6	20	20	0,60
000189140Z	140 mm	80 mm	30 mm	Verzinkt	2,0 mm	6	20	20	1,29
000189075S	70 mm	36 mm	16 mm	Zwart	1,5 mm	6	50	50	0,82

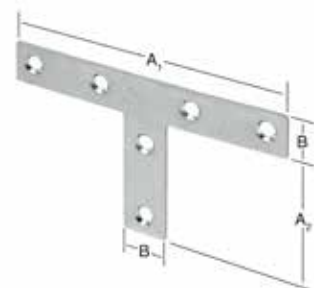

HOEKEN

Raamhoek

Code 29

Art. Nr.	Afm. A	Afm. A	Afm. B	Kleur	dikte	gaten	VE	MBH	Prijs €
000186030Z	30 mm	30 mm	10 mm	Verzinkt	1,5 mm	4	100	100	0,25
000186040Z	40 mm	40 mm	10 mm	Verzinkt	1,5 mm	4	100	100	0,16
000186050Z	50 mm	50 mm	10 mm	Verzinkt	1,5 mm	4	100	100	0,28
000186060Z	60 mm	60 mm	10 mm	Verzinkt	1,5 mm	4	100	100	0,22
000186075Z	75 mm	75 mm	10 mm	Verzinkt	1,5 mm	4	100	100	0,25
000186075S	75 mm	75 mm	12 mm	Zwart	1,5 mm	4	100	100	0,66

Raamhoek

Code 29

Art. Nr.	Afm. A	Afm. A	Afm. B	Kleur	dikte	gaten	VE	MBH	Prijs €
000187100Z	100 mm	100 mm	15 mm	Verzinkt	1,5 mm	5	20	20	0,41
000187120Z	120 mm	120 mm	20 mm	Verzinkt	2,0 mm	5	20	20	0,69
000187160Z	160 mm	160 mm	22 mm	Verzinkt	2,5 mm	6	20	20	1,26
000187200Z	200 mm	200 mm	30 mm	Verzinkt	3,0 mm	6	20	20	2,36
000187250Z	250 mm	250 mm	30 mm	Verzinkt	3,5 mm	5	10	10	9,86
000187100S	100 mm	100mm	15 mm	Zwart	1,5 mm	4	20	20	0,85
000187120S	120 mm	120mm	20 mm	Zwart	1,5 mm	4	20	20	1,10
000187100W	100 mm	100mm	15 mm	Wit	1,5 mm	4	20	20	0,85

Code 29

Art. Nr.	Afm. A	Afm. A	Afm. B	Kleur	dikte	gaten	VE	MBH	Prijs €
000188100Z	100 mm	100 mm	15 mm	Verzinkt	1,5 mm	5	20	20	0,41
000188120Z	120 mm	120 mm	20 mm	Verzinkt	2,0 mm	5	20	20	0,82
000188120	120 mm	120 mm	20 mm	RVS-V2A	2,0 mm	6	20	20	2,14

Verbindingsplaat verzinkt

Code 29

Art. Nr.	Afm. A	Afm. B	Kleur	dikte	gaten	VE	MBH	Prijs €
000183050Z	50 mm	15 mm	Verzinkt	2,0 mm	2	100	100	0,16
000183060Z	60 mm	15 mm	Verzinkt	2,0 mm	2	100	100	0,19
000183080Z	80 mm	15 mm	Verzinkt	2,0 mm	4	100	100	0,22
000183100Z	100 mm	15 mm	Verzinkt	2,0 mm	4	100	100	0,25
000183120Z	116 mm	18 mm	Verzinkt	2,0 mm	4	100	100	0,35
000183200Z	200 mm	20 mm	Verzinkt	2,0 mm	4	100	100	0,60
000183100S	100 mm	15 mm	Zwart	2,0 mm	4	100	100	0,66
010183100	100 mm	15 mm	RVS-V2A	2,0 mm	4	50	50	0,63

Verbindingsplaat dik verzinkt

Code 29

Art. Nr.	Afm. A	Afm. B	Kleur	dikte	gaten	VE	MBH	Prijs €
000184170Z	170 mm	15 mm	Verzinkt	3,0 mm	6	50	50	0,95
000184190Z	190 mm	15 mm	Verzinkt	4,0 mm	9	20	20	1,70
000184170S	170 mm	15 mm	Zwart	3,0 mm	6	50	50	1,29

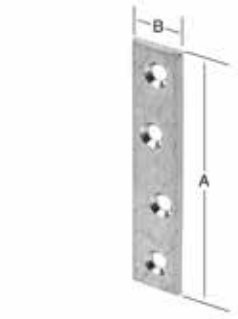
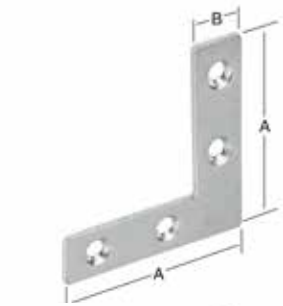

HOEKEN

Gordijnenhoek

Code 29

Art. Nr.	Afm. A	Afm. A2	Afm. B	Kleur	dikte	gaten	VE	MBH	Prijs €
000160095Z	80 mm	55 mm	17 mm	Verzinkt	3,5 mm	4/1	20	20	0,72
000160120Z	120 mm	55 mm	17 mm	Verzinkt	3,5 mm	4/1	20	20	1,01
000160180Z	180 mm	55 mm	17 mm	Verzinkt	3,5 mm	4/1	20	20	1,35



Gordijnenhoek

Code 29

Art. Nr.	Afm. A	Afm. A2	Afm. B	Kleur	dikte	gaten	VE	MBH	Prijs €
000160095W	80 mm	65 mm	20 mm	wit	4,0 mm	2/1	20	20	1,13
000160120W	120 mm	55 mm	17 mm	wit	3,5 mm	4/1	20	20	1,39
000160180W	180 mm	55 mm	17 mm	wit	3,5 mm	4/1	20	20	1,89



Hoekbeugel verzinkt, zwart of wit 80x65x20 mm

Code 29

Art. Nr.	Afm. A	Afm. A2	Afm. B	Kleur	dikte	gaten	VE	MBH	Prijs €
000178080Z	80 mm	65 mm	20 mm	Verzinkt	2,0 mm	7/2	20	20	0,79
000178080W	80 mm	65 mm	20 mm	Wit	2,0 mm	7/2	20	20	1,29
000178080S	80 mm	65 mm	20 mm	Zwart	2,0 mm	7/2	20	20	1,29



Verstelbare winkelhaak verzinkt, wit of RVS 70x35x50 mm met 7 gaten

Code 29

Art. Nr.	Afm. A	Afm. B1	Afm. B2	Kleur	dikte	gaten	VE	MBH	Prijs €
000175070Z	70 mm	35 mm	50 mm	Verzinkt	2,0 mm	7/2	20	20	0,91
000175070W	70 mm	35 mm	50 mm	Wit	2,0 mm	7/2	20	20	1,29
071200000RF	70 mm	35 mm	50 mm	RVS-V4A	2,0 mm	7/2	10	10	4,41



Verstelbare winkel haak met 3/4 gaten verzinkt 75x35x60 mm

Code 29

Art. Nr.	Afm. A1	Afm. A2	Afm. B	Kleur	dikte	gaten	VE	MBH	Prijs €
000176075Z	75 mm	35 mm	65 mm	Verzinkt	3,5 mm	3/4	10	10	1,76



Verbindingsplaat zwart

Code 29

Art. Nr.	Afm. A	Afm. B	Kleur	dikte	gaten	VE	MBH	Prijs €
070001000K	80 mm	50 mm	Zwart	2,3 mm	4/8	25	25	1,95
070003000K	120 mm	50 mm	Zwart	2,3 mm	12/8/2	25	25	2,27
070005000K	160 mm	50 mm	Zwart	2,3 mm	14/12/2	25	25	2,68



HOUTVERBINDERS

De hoekverbinders zijn gemaakt van een sterker metaal als de standaard hoeken. ze daarnaast ook **Sendzimir** verzinkt.

Sendzimir is een thermisch verzinkte staalsoort. Bij het thermische zinkproces wordt het staal met een hoge snelheid door een zinkbad gehaald, Door een chemische reactie smelten zink en staal samen tot een legering. Hierdoor wordt het staal sterker en is het beter bestand tegen roest. Zelfs bij een kleine kras in het metaal is de sendzimir laag vaak dik genoeg om roesten te voorkomen.

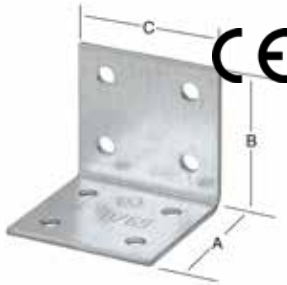

CE Hoekanker

Code 29

Art. Nr.	Afm. A	Afm. B	Afm. C	Kleur	dikte	gaten	VE	MBH	Prijs €
070903000	40 mm	40 mm	20 mm	Verzinkt	2,0 mm	4	100	100	0,22
070904000	40 mm	40 mm	40 mm	Verzinkt	2,0 mm	4	100	100	0,35
070905000	50 mm	50 mm	40mm	Verzinkt	2,0 mm	4	100	100	0,41



Code 29

Art. Nr.	Afm. A	Afm. B	Afm. C	Kleur	dikte	gaten	VE	MBH	Prijs €
070904000RF	40 mm	40 mm	40 mm	RVS-V4A	2,0 mm	4	25	25	1,20
070905000RF	50 mm	50 mm	40mm	RVS-V4A	2,0 mm	4	25	25	1,89



CE Hoekanker zonder ril,

Code 29

Art. Nr.	Afm. A	Afm. B	Afm. C	Kleur	dikte	gaten	VE	MBH	Prijs €
070921000	50 mm	50 mm	35 mm	Verzinkt	2,5 mm	12/2	50	50	0,47
070923000	60 mm	60 mm	45 mm	Verzinkt	2,5 mm	12/2	50	50	0,69
070924000	70 mm	70 mm	55 mm	Verzinkt	2,5 mm	18/2	50	50	0,95
070925000	90 mm	90 mm	65 mm	Verzinkt	2,5 mm	26/2	50	50	1,39
070926000	105mm	105 mm	90 mm	Verzinkt	3,0 mm	28/6	25	25	2,58
070929000	92 mm	92 mm	40 mm	Verzinkt	2,5 mm	16/4	50	50	0,91



Code 29

Art. Nr.	Afm. A	Afm. B	Afm. C	Kleur	dikte	gaten	VE	MBH	Prijs €
070924000RF	70 mm	70 mm	55 mm	RVS	2,0 mm	18/2	25	25	3,47
070925000RF	90 mm	90 mm	65 mm	RVS	2,0 mm	24/2	25	25	4,98
070926000RF	105mm	105 mm	90 mm	RVS	2,5 mm	24/6	25	25	10,17
070929000RF	90 mm	90 mm	40 mm	RVS	2,0 mm	24/2	10	10	3,21



CE Hoekanker met ril,

Code 29

Art. Nr.	Afm. A	Afm. B	Afm. C	Kleur	dikte	gaten	VE	MBH	Prijs €
071194000	90 mm	48 mm	48 mm	Verzinkt	3,0 mm	12/3	20	20	1,01
071194016	75 mm	75 mm	65 mm	Verzinkt	1,5 mm	13/2	50	50	0,72
071194020	75 mm	75 mm	65 mm	Verzinkt	2,5 mm	13/2	50	50	0,88
071195000	90 mm	48 mm	76 mm	Verzinkt	3,0 mm	16/5	50	50	1,51

HOUTVERBINDERS

Hoekanker met ril,

Code 29



Art. Nr.	Afm. A	Afm. B	Afm. C	Kleur	dikte	gaten	VE	MBH	Prijs €
070931000	70 mm	70 mm	55 mm	Verzinkt	2,5 mm	18/2	50	50	0,91
070932000	90 mm	90 mm	65 mm	Verzinkt	2,5 mm	26/2	50	50	1,39
070933000	105mm	105 mm	90 mm	Verzinkt	3,0 mm	24/6	25	25	2,55

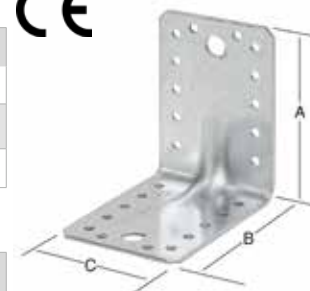

Code 29

Art. Nr.	Afm. A	Afm. B	Afm. C	Kleur	dikte	gaten	VE	MBH	Prijs €
070931000RF	70 mm	70 mm	55 mm	RVS-V4A	2,0 mm	18/2	25	25	3,47
070932000RF	90 mm	90 mm	65 mm	RVS-V4A	2,0 mm	26/2	10	10	5,07
070933000RF	105mm	105 mm	90 mm	RVS-V4A	2,0 mm	28/6	10	10	9,89



Hoekanker verzinkt

Code 29



Art. Nr.	Afm. A	Afm. B	Afm. C	Kleur	dikte	gaten	VE	MBH	Prijs €
070912000	60 mm	40 mm	60mm	Verzinkt	2,5 mm	13/2	20	20	0,79
070913000	80 mm	60 mm	60mm	Verzinkt	2,5 mm	18/2	50	50	1,04
070914000	100 mm	60 mm	60 mm	Verzinkt	2,5 mm	20/3	50	50	1,20
070917000	120 mm	90 mm	40 mm	Verzinkt	4,0 mm	18/4	50	50	1,73
070918000	90 mm	35 mm	40 mm	Verzinkt	2,5 mm	11/2	50	50	0,69
070919000	110 mm	35 mm	40 mm	Verzinkt	2,5 mm	13/3	50	50	0,79
070920000	145 mm	35 mm	40 mm	Verzinkt	2,5 mm	15/14	50	50	0,98

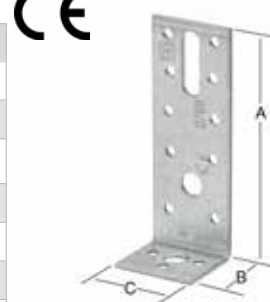

Hoekoppelplaat verzinkt & RVS

Code 29



Art. Nr.	Afm. A	Afm. B	Afm. C	Kleur	dikte	gaten	VE	MBH	Prijs €
070934000	40 mm	40 mm	60 mm	Verzinkt	2,5 mm	10	50	50	0,63
070935000	60 mm	60 mm	40 mm	Verzinkt	2,5 mm	12	50	50	0,63
070936000	60 mm	60 mm	50 mm	Verzinkt	2,5 mm	12	50	50	0,76
070937000	60 mm	60 mm	60 mm	Verzinkt	2,5 mm	16	50	50	0,88
070938000	60 mm	60 mm	80 mm	Verzinkt	2,5 mm	20	50	50	1,13

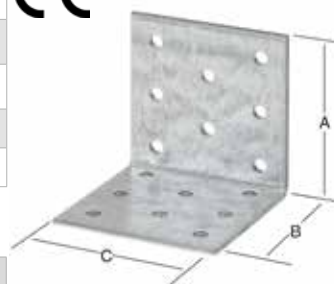

Code 29

Art. Nr.	Afm. A	Afm. B	Afm. C	Kleur	dikte	gaten	VE	MBH	Prijs €
070934000RF	40 mm	40 mm	60 mm	RVS-V4A	2,0 mm	12	25	25	1,76
070935000RF	60 mm	60 mm	40 mm	RVS-V4A	2,0 mm	12	25	25	2,24
070937000RF	60 mm	60 mm	60 mm	RVS-V4A	2,0 mm	12	10	10	3,31



Verzinkte/RVS verbindingsplaat

Code 29



Art. Nr.	Afm. A	Afm. B	Kleur	dikte	gaten	VE	MBH	Prijs €
070900000	96 mm	35 mm	Verzinkt	2,5 mm	12/2	50	50	0,44
070901000	116 mm	45 mm	Verzinkt	2,5 mm	12/2	50	50	0,66
070902000	136 mm	55 mm	Verzinkt	2,5 mm	18/2	50	50	0,95
070906000	175 mm	65 mm	Verzinkt	2,5 mm	26/2	50	50	1,35
070907000	200 mm	90 mm	Verzinkt	2,5 mm	28/6	25	25	2,58
070909000	180 mm	40 mm	Verzinkt	2,5 mm	16/4	50	50	0,91
070900000RF	96 mm	35 mm	RVS-V4A	2,5 mm	12/2	25	25	1,64
070902000RF	136 mm	55 mm	RVS-V4A	2,5 mm	18/2	10	10	3,50

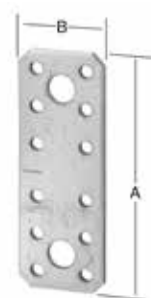

HOUTVERBINDERS

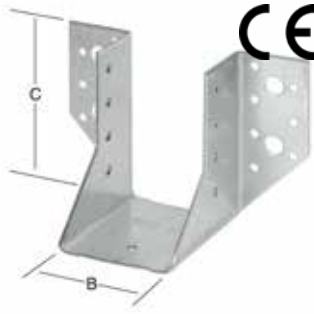

Verzinkte zware balkendrager met 22,26 of 36 gaten

Art. Nr.	Afm. B	Afm. C	Kleur	dikte	gaten	VE	MBH	
070970000	40 mm	100 mm	Verzinkt	2,0 mm	22/4	10	10	
070972000	60 mm	100 mm	Verzinkt	2,0 mm	22/4	10	10	
070973000	70 mm	120 mm	Verzinkt	2,0 mm	26/6	10	10	2,80
070973152	76 mm	152 mm	Verzinkt	2,0 mm	26/6	10	10	3,21
070974000	80 mm	120 mm	Verzinkt	2,0 mm	26/4	10	10	2,68
070975000	100 mm	140 mm	Verzinkt	2,0 mm	26/4	10	10	3,15
070976000	120 mm	160 mm	Verzinkt	2,0 mm	36/6	10	10	3,72

Code 29

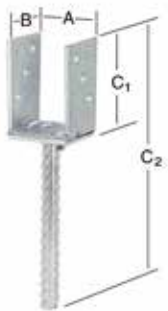

Verstelbare balkensteun met geribbelde stalen drager Ø 20x200mm, zijwaarts verstelbaar van 60 tot 140 mm

Code 29

Art. Nr.	Afm. A	Afm. B	Afm. C	Kleur	dikte	gaten	VE	MBH	Prijs €
071325000CE	60 mm / 140mm	70 mm	115mm / 315mm	Verzinkt	4,5 mm	6/8	1	1	15,34

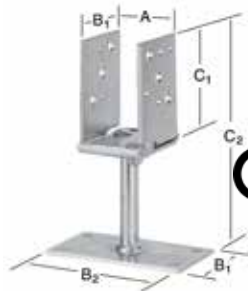

Verstelbare balkensteun op steunplaat schroefbaar, zijwaarts verstelbaar van 60 tot 140 mm

Code 29

Art. Nr.	Afm. A	Afm. B	Afm. C	Kleur	dikte	gaten	VE	MBH	Prijs €
071326000CE	60 mm / 140mm	70 mm / 150 mm	115mm / 215mm	Verzinkt	4,5 mm	8/10	1	1	21,96

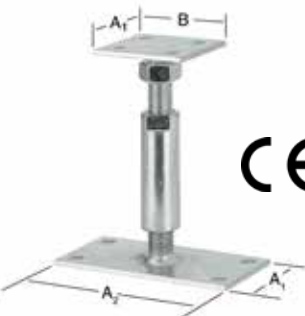

Balkensteun op steunplaat schroefbaar en in hoogte verstelbaar

Code 29

Art. Nr.	Afm. A	Afm. A2	Afm. B	Kleur	dikte	gaten	VE	MBH	Prijs €
071329000CE	150 mm	70 mm	80 mm	Verzinkt	4,5 mm	8	1	1	25,42



Verstelbare balkensteun op steunplaat schroefbaar, in hoogte verstelbaar en zijwaarts verstelbaar van 60 tot 140 mm

Code 29

Art. Nr.	Afm. A	Afm. B	Afm. C	Kleur	dikte	gaten	VE	MBH	Prijs €
071331000CE	60 mm / 140mm	70 mm / 150 mm	115 mm	Verzinkt	4,5 mm	8/10	1	1	34,43

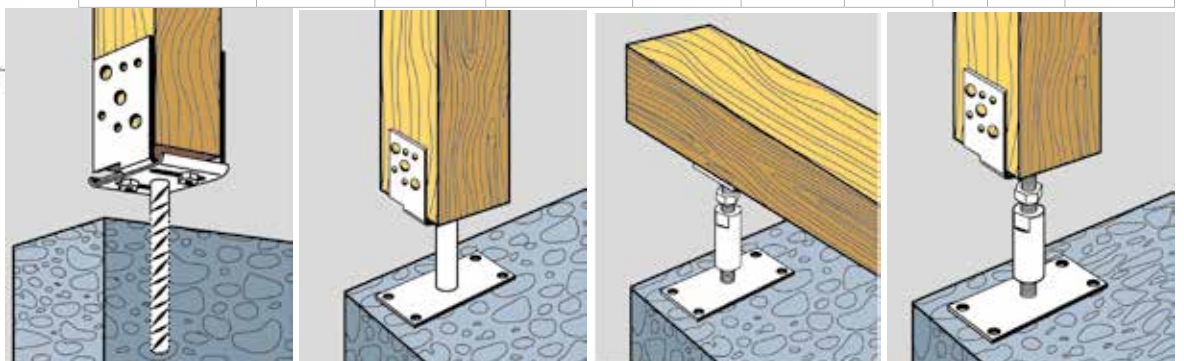

KISTSLUITINGEN

iting RVS-V2A met mogelijkheid voor hangslot

Code 29

Nr.	Afm. A	Afm. B	Afm. C	Kleur	hoogte	gaten	VE	MBH	Prijs €
09105	110 mm	37 mm	Ø 4 mm	RVS-V2A	24 mm	3	20	20	6,17



Kistsluiting RVS-V2A en Verzinkt

Code 29

Art. Nr.	Afm. A	Afm. B	Afm. C	Kleur	hoogte	gaten	VE	MBH	Prijs €
011202050	52 mm	23 mm	Ø 3 mm	RVS-V2A	11 mm	2	20	20	2,30
011202105	110 mm	37 mm	Ø 4 mm	RVS-V2A	12 mm	2	20	20	4,85
001202050Z	52 mm	23 mm	Ø 3 mm	Verzinkt	11 mm	2	50	50	1,54
001202070Z	70 mm	31 mm	Ø 4 mm	Verzinkt	13 mm	2	50	50	1,83



Kistsluiting RVS-V2A

Code 29

Art. Nr.	Afmetingen	Materiaal	VE	MBH	Prijs €
011203000	125 x 33 mm	RVS-V2A	20	20	21,77



Sluithaken RVS voor zijsluiting

Code 29

Art. Nr.	Afm. A	Afm. B	Kleur	dikte	gaten	VE	MBH	Prijs €
000009018Z	gehoekt	48 mm	Verzinkt	2,0 mm	3	50	50	0,25
000008025Z	recht	82 mm	Verzinkt	2,5mm	3	25	25	0,57
010008018	recht	44 mm	RVS-V2A	2,0 mm	2	20	20	0,60
010008025	recht	83 mm	RVS-V2A	2,0 mm	3	20	20	1,20
010008115	recht	46 mm	RVS-V2A	2,0 mm	2	20	20	0,57



Sluithaken RVS voor dekselsluiting

Code 29

Art. Nr.	Afm. A	Afm. B	Kleur	dikte	gaten	VE	MBH	Prijs €
010009015	46 mm	15 mm	RVS-V2A	2,0 mm	2	20	20	0,54
010009018	46 mm	18 mm	RVS-V2A	2,0 mm	2	20	20	0,60
010009025	83 mm	25 mm	RVS-V2A	2,0 mm	3	20	20	1,23



Kisthoek verzinkt of RVS staal

Code 29

Art. Nr.	Afm. A	Kleur	dikte	gaten	VE	MBH	Prijs €
000240028Z	28 mm	Verzinkt	0,9 mm	3	25	25	1,45
000240036Z	36 mm	Verzinkt	1,0 mm	3	25	25	1,48
000240045Z	45 mm	Verzinkt	1,0 mm	3	10	10	1,48
000240056Z	56 mm	Verzinkt	0,9 mm	3	25	25	3,28
010240036	36 mm	RVS	1,0 mm	3	20	20	2,43



Kistscharnier

Code 29



Art. Nr.	Afmetingen	Materiaal	VE	MBH	Prijs €
000044150Z	292x33 mm	Verzinkt	20	20	1,51
000044200Z	390x44 mm	Verzinkt	10	10	3,87

Kistscharnier RVS

Code 29

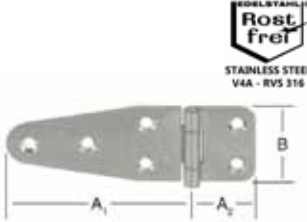

Art. Nr.	Afmetingen	Materiaal	VE	MBH	Prijs €
010043080	80x37 mm	RVS-V2A	20	20	4,03
010046160	160x37 mm	RVS-V2A	20	20	4,76

Kistgreep

Code 29



Art. Nr.	Afm. A	Afm. B	Greep	Kleur	hoogte	gaten	VE	MBH	Prijs €
011328100	100 mm	80 mm	Ø 7,5mm	RVS-V2A	11 mm	4	5	5	6,90
001328100Z	100 mm	80 mm	Ø 7,5mm	Verzinkt	11 mm	4	10	10	2,49
001328100S	100 mm	80 mm	Ø 7,5mm	Zwart	11 mm	4	10	10	4,44
001328080Z	80 mm	70 mm	Ø 6,5mm	Verzinkt	11 mm	4	10	10	1,54

Grendel verzinkt staal

Code 29



Art. Nr.	Afm. A	Afm. B	Kleur	Dikte	gaten	VE	MBH	Prijs €
000021140Z	85mm / 30 mm	35 mm	Verzinkt	2,5 mm	8/1	10	10	2,17
000021160Z	105mm / 55mm	35 mm	Verzinkt	2,5 mm	8/1	10	10	2,55
000021180Z	125mm / 55 mm	35 mm	Verzinkt	2,5 mm	8/1	10	10	2,90
010021145	100mm / 45 mm	35 mm	RVS-V2A	2,0 mm	7/1	5	5	8,41

Overvalsluiting 80x30 mm RVS

Code 29



Art. Nr.	Afm. A	Afm. B	Kleur	Dikte	gaten	VE	MBH	Prijs €
010090080	80mm / 30 mm	37 mm	RVS-V2A	1,5 mm	2/4	5	5	5,58

Overslagsluiting verzinkt staal

Code 29



Art. Nr.	Afm. A	Afm. B	Kleur	Dikte	gaten	VE	MBH	Prijs €
000080080Z	80 mm	22 mm	Verzinkt	1,3 mm	5	10	10	1,26
000080100Z	100 mm	30 mm	Verzinkt	1,3 mm	5	10	10	1,70

Oogplaat verzinkt

Code 29

Art. Nr.	Afm. A	Afm. B	Afm. C	Kleur	dikte	gaten	VE	MBH	Prijs €
000075035Z	35 mm	25 mm		Verzinkt	2,0 mm	4	25	25	0,50
000075075Z	44 mm	41 mm		Verzinkt	2,5 mm	4	5	5	1,13



Oogplaat verzinkt

Code 29

Art. Nr.	Afm. A	Afm. B	Afm. C	Kleur	dikte	gaten	VE	MBH	Prijs €
000076040Z	40 mm	28 mm		Verzinkt	1,0 mm	2	25	25	0,60
000076045Z	45 mm	31 mm		Verzinkt	1,25mm	2	25	25	0,82



Stormhaak deurvergrendeling verzinkt

Code 29

Art. Nr.	Afm. A	Afm. B	Afm. C	Kleur	dikte	gaten	VE	MBH	Prijs €
000083100Z	100 mm	43 mm		Verzinkt	5,2 mm	4	10	10	2,46
000083120Z	120 mm	43 mm		Verzinkt	5,8 mm	4	10	10	2,87
000083200Z	200 mm	35 mm		Verzinkt	6,0 mm	8	5	5	3,62
000083250Z	250 mm	35 mm		Verzinkt	6,0 mm	8	5	5	4,00



Tuinheksluiting verzinkt

Code 29

Art. Nr.	Afm,A1	Afm,A2	Afm,B1	Afm,B2	Kleur	dikte	gaten	VE	MBH	Prijs €
000085000Z	100mm	183mm	80 mm	20mm	Verzinkt	2/5mm	4/2	10	10	10,21



Grendel dubbeledeur afsluitbaar

Code 29

Art. Nr.	Afm,A1	Afm,A2	Afm,B1	Afm,B2	Kleur	dikte	gaten	VE	MBH	Prijs €
000086000Z	340mm	180mm	30 mm	70mm	Verzinkt	3,0mm	10	5	5	17,77

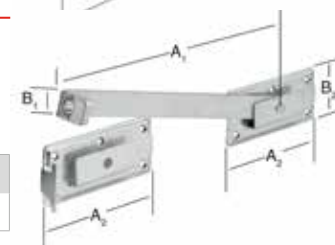

Grendel afsluitbaar rvs

Code 29

Art. Nr.	Afm. A	Afm. B	Afm. C	Kleur	dikte	gaten	VE	MBH	Prijs €
010105120	120 mm	56 mm		RVS-V2A	1,5 mm	5	5	5	8,95
010105140	140 mm	56 mm		RVS-V2A	1,5 mm	5	5	5	10,30

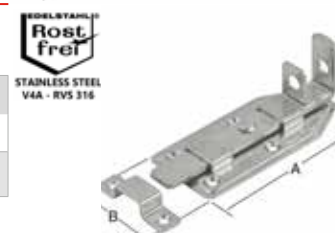

Schuif recht RVS

Code 29

Art. Nr.	Afmetingen	Materiaal	VE	MBH	Prijs €
010102080	80x30 mm	RVS-V2A	10	10	6,58
010102100	100x35 mm	RVS-V2A	5	5	7,37



Handgreep

Code 29

Art. Nr.	Afmetingen	Materiaal	VE	MBH	Prijs €
010193160	160x20 mm	RVS-V2A	5	5	4,13
010193200	200x20 mm	RVS-V2A	10	10	4,63



SCHARNIEREN

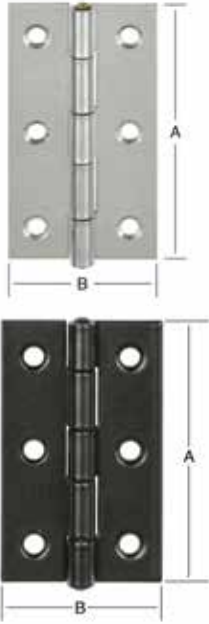

Gerold smalle scharnieren DIN7954A
met vaste messing stift

Code 29

Art. Nr.	Afm. A	Afm. B	Uitvoering	Kleur	dikte	gaten	VE	MBH	Prijs €
000501030Z	30 mm	22 mm	Messing stift	Verzinkt	0,9 mm	4	50	50	0,54
000501040Z	40 mm	26 mm	Messing stift	Verzinkt	0,9 mm	4	50	50	0,47
000501050Z	50 mm	31 mm	Messing stift	Verzinkt	1,2 mm	6	20	20	0,63
000501060Z	60 mm	34 mm	Messing stift	Verzinkt	1,4 mm	6	20	20	0,76
000501070Z	70 mm	38 mm	Messing stift	Verzinkt	1,4 mm	6	20	20	1,26
000501080Z	80 mm	41 mm	Messing stift	Verzinkt	1,5 mm	6	20	20	1,35
000501100Z	100mm	52 mm	Messing stift	Verzinkt	1,6 mm	8	20	20	2,11
000501060S	60 mm	34 mm	Messing stift	Zwart	1,4 mm	6	20	20	1,32
000501080S	80 mm	41 mm	Messing stift	Zwart	1,5 mm	6	10	10	1,89



Gerold smalle RVS-V2A scharnieren
met vaste RVS stift

Code 29

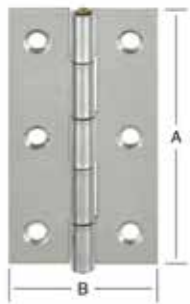

Art. Nr.	Afm. A	Afm. B	Uitvoering	Kleur	dikte	gaten	VE	MBH	Prijs €
010501030	30 mm	22 mm	RVS stift	RVS-V2A	0,8 mm	4	50	50	1,17
010501040	40 mm	26 mm	RVS stift	RVS-V2A	0,9 mm	4	50	50	1,20
010501050	50 mm	31 mm	RVS stift	RVS-V2A	1,0 mm	6	20	20	1,42
010501060	60 mm	34 mm	RVS stift	RVS-V2A	1,2 mm	6	10	10	1,64
010501080	80 mm	41 mm	RVS stift	RVS-V2A	1,5 mm	6	10	10	2,39
010501100	100mm	52 mm	RVS stift	RVS-V2A	1,5 mm	8	10	10	3,21

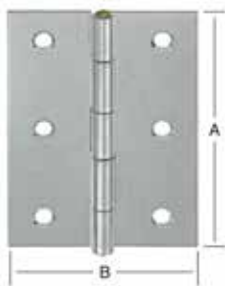

Gerold halfbrede verzinkte scharnieren
DIN 7954 B met vaste messing stift

Code 29

Art. Nr.	Afm. A	Afm. B	Uitvoering	Kleur	dikte	gaten	VE	MBH	Prijs €
000502025Z	25 mm	22 mm	messing stift	Verzinkt	0,8 mm	4	50	50	0,47
000502030Z	30 mm	26 mm	messing stift	Verzinkt	0,9 mm	4	50	50	0,44
000502040Z	40 mm	32 mm	messing stift	Verzinkt	0,9 mm	4	50	50	0,50
000502050Z	50 mm	39 mm	messing stift	Verzinkt	1,2 mm	6	20	20	0,66
000502060Z	60 mm	46 mm	messing stift	Verzinkt	1,4 mm	6	20	20	0,85
000502070Z	70 mm	51 mm	messing stift	Verzinkt	1,4 mm	6	20	20	1,17
000502080Z	80 mm	58 mm	messing stift	Verzinkt	1,5 mm	6	20	20	1,54
000502090Z	90 mm	63 mm	messing stift	Verzinkt	1,5 mm	6	20	20	2,11
000502100Z	100mm	72 mm	messing stift	Verzinkt	1,6 mm	8	20	20	2,65



Gerold halfbrede scharnieren RVS

Code 29

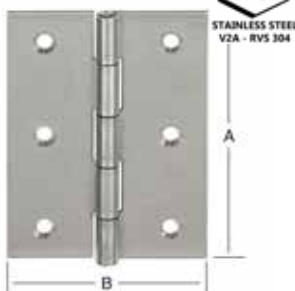

Art. Nr.	Afm. A	Afm. B	Uitvoering	Kleur	dikte	gaten	VE	MBH	Prijs €
010502040	40 mm	32 mm	RVS stift	RVS-V2A	1,0 mm	4	50	50	1,23
010502050	50 mm	39 mm	RVS stift	RVS-V2A	0,9 mm	6	20	20	1,48
010502060	60 mm	46 mm	RVS stift	RVS-V2A	1,2 mm	6	20	20	1,80
010502080	80 mm	58 mm	RVS stift	RVS-V2A	1,2 mm	6	20	20	2,71
010502100	100mm	72 mm	RVS stift	RVS-V2A	1,5 mm	8	20	20	3,69

SCHARNIEREN

Gerold koekige verzinkte scharnieren
DIN 7954 C met vaste messing stift

Code 29

Art. Nr.	Afm. A	Afm. B	Uitvoering	Kleur	dikte	gaten	VE	MBH	Prijs €
000503025Z	25 mm	25 mm	messaging stift	Verzinkt	0,8 mm	4	50	50	0,60
000503030Z	30 mm	30 mm	messaging stift	Verzinkt	0,9 mm	4	50	50	0,50
000503040Z	40 mm	40 mm	messaging stift	Verzinkt	0,9 mm	4	50	50	0,50
000503050Z	50 mm	50 mm	messaging stift	Verzinkt	1,2 mm	6	20	20	0,72
000503060Z	60 mm	60 mm	messaging stift	Verzinkt	1,4 mm	6	20	20	0,91
000503070Z	70 mm	70 mm	messaging stift	Verzinkt	1,4 mm	6	20	20	1,32
000503080Z	80 mm	80 mm	messaging stift	Verzinkt	1,5 mm	6	20	20	1,70
000503090Z	90 mm	90 mm	messaging stift	Verzinkt	1,5 mm	8	20	20	2,39
000503100Z	100mm	100mm	messaging stift	Verzinkt	1,6 mm	8	20	20	2,77
000503060S	60 mm	60 mm	messaging stift	Zwart	1,4 mm	6	10	10	1,48
000503080S	80 mm	80 mm	messaging stift	Zwart	1,5 mm	6	20	20	2,30

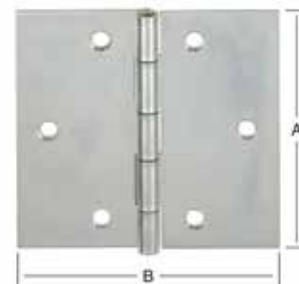

Gerold vierkante knoopscharnier RVS

Code 29

Art. Nr.	Afm. A	Afm. B	Uitvoering	Kleur	dikte	gaten	VE	MBH	Prijs €
010503030	30 mm	30 mm	RVS stift	RVS-V2A	0,8 mm	4	50	50	1,17
010503040	40 mm	40 mm	RVS stift	RVS-V2A	0,9 mm	4	50	50	1,29
010503050	50 mm	50 mm	RVS stift	RVS-V2A	1,0 mm	6	20	20	1,64
010503060	60 mm	60 mm	RVS stift	RVS-V2A	1,2 mm	6	10	10	1,98
010503070	70 mm	70 mm	RVS stift	RVS-V2A	1,2 mm	6	10	10	2,84
010503080	80 mm	80 mm	RVS stift	RVS-V2A	1,5 mm	6	10	10	3,43



Gerold breede scharnieren
DIN 7954 C met vaste Messing stift

Code 29

Art. Nr.	Afm. A	Afm. B	Uitvoering	Kleur	dikte	gaten	VE	MBH	Prijs €
000504030Z	30 mm	45 mm	messaging stift	Verzinkt	0,9 mm	6	50	50	0,72
000504040Z	40 mm	60 mm	messaging stift	Verzinkt	1,2 mm	6	20	20	1,07
000504050Z	50 mm	75 mm	messaging stift	Verzinkt	1,2 mm	8	20	20	1,07
000504060Z	60 mm	90 mm	messaging stift	Verzinkt	1,4 mm	8	20	20	1,48
000504080Z	80 mm	120mm	messaging stift	Verzinkt	1,8 mm	8	20	20	2,80
000504060S	60 mm	90 mm	messaging stift	Verzinkt	1,4 mm	8	20	20	1,98
000504080S	80 mm	120mm	messaging stift	Verzinkt	1,8 mm	8	20	20	3,78

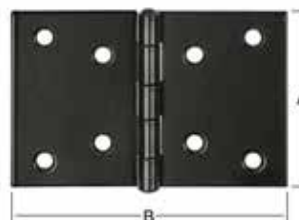

Gerold breed knoopscharnier RVS

Code 29

Art. Nr.	Afm. A	Afm. B	Uitvoering	Kleur	dikte	gaten	VE	MBH	Prijs €
010504030	30 mm	45 mm	RVS stift	RVS-V2A	1,0 mm	6	50	50	2,55
010504040	40 mm	60 mm	RVS stift	RVS-V2A	0,9 mm	6	20	20	1,51
010504050	50 mm	75 mm	RVS stift	RVS-V2A	1,2 mm	8	10	10	2,14
010504060	60 mm	90 mm	RVS stift	RVS-V2A	1,2 mm	8	10	10	2,52
010504080	80 mm	120mm	RVS stift	RVS-V2A	1,5 mm	8	10	10	4,85

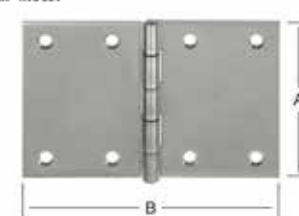

SCHARNIEREN

Gerold tafelscharnier verzinkt
DIN 7957 met vaste messing stift

Code 29

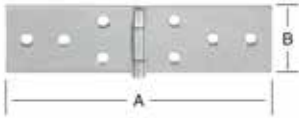

Art. Nr.	Afm. A	Afm. B	Afm. C	Kleur	dikte	gaten	VE	MBH	Prijs €
000505050Z	50 mm	23 mm	messing stift	Verzinkt	0,9 mm	6	20	20	0,82
000505060Z	60 mm	25 mm	messing stift	Verzinkt	0,9 mm	6	20	20	0,72
000505080Z	80 mm	28 mm	messing stift	Verzinkt	1,2 mm	6	20	20	0,85
000505100Z	100mm	32 mm	messing stift	Verzinkt	1,3 mm	6	20	20	1,01
000505120Z	120mm	33 mm	messing stift	Verzinkt	1,4 mm	8	20	20	1,17
000505140Z	140mm	34 mm	messing stift	Verzinkt	1,6 mm	8	20	20	1,39
000505160Z	160mm	37 mm	messing stift	Verzinkt	1,7 mm	8	20	20	2,11
000505180Z	180mm	40 mm	messing stift	Verzinkt	1,7 mm	8	10	10	2,55
000505200Z	200mm	44 mm	messing stift	Verzinkt	2,0 mm	8	20	20	3,12
000505250Z	250mm	44 mm	messing stift	Verzinkt	2,0 mm	10	20	20	3,53



Gerold breed tafelscharnier RVS

Code 29

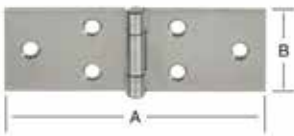

Art. Nr.	Afm. A	Afm. B	Afm. C	Kleur	dikte	gaten	VE	MBH	Prijs €
010505080	80 mm	28 mm	RVS stift	RVS-V2A	1,0 mm	6	10	10	1,64
010505100	100 mm	32 mm	RVS stift	RVS-V2A	1,2 mm	6	10	10	2,52
010505120	120 mm	33 mm	RVS stift	RVS-V2A	1,2 mm	8	10	10	2,74
010505140	140 mm	34 mm	RVS stift	RVS-V2A	1,5 mm	8	10	10	3,28
010505160	160 mm	37 mm	RVS stift	RVS-V2A	1,5 mm	8	10	10	4,88

Gerold tafelscharnier verzinkt
met vaste metalen stift

Code 29

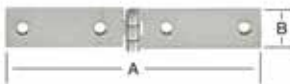

Art. Nr.	Afm. A	Afm. B	Afm. C	Kleur	dikte	gaten	VE	MBH	Prijs €
000506100Z	100mm	20 mm	metalen stift	Verzinkt	1,5 mm	4	50	50	0,66
000506120Z	120mm	20 mm	metalen stift	Verzinkt	1,5 mm	4	50	50	0,69
000506815Z	80 mm	15 mm	metalen stift	Verzinkt	1,5 mm	4	50	50	1,51
000506820Z	80mm	20 mm	metalen stift	Verzinkt	1,5 mm	4	50	50	0,76

Extra breede en sterk scharnier gerolde tafelscharnier verzinkt
met vaste messing stift

Code 29

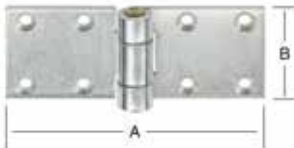

Art. Nr.	Afm. A	Afm. B	Afm. C	Kleur	dikte	gaten	VE	MBH	Prijs €
000048130Z	130mm	50 mm	messing stift	Verzinkt	4,0 mm	8	10	10	6,21
000048180Z	180mm	50 mm	messing stift	Verzinkt	4,0 mm	10	5	5	7,34

Schoolbordscharnier

Code 29

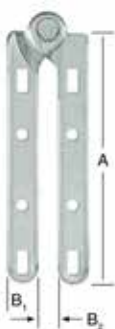

Art. Nr.	Afm. A	Afm. B	Afm. C	Kleur	dikte	gaten	VE	MBH	Prijs €
000019001Z	150mm	10 mm	Links	Verzinkt	4,0 mm	8	50	50	5,73
000019011Z	150mm	10 mm	Rechts	Verzinkt	4,0 mm	8	50	50	5,73

SCHARNIEREN

Kulissescharnier Verzinkt

Code 29

Art. Nr.	Afm. A	Afm. B	Afm. C	Kleur	dikte	Pen	VE	MBH	Prijs €
000056070RI	70 mm	55 mm	2mm Axial	Verzinkt	3,0 mm	Ø 6 mm	50	50	1,64
000057160RI	60 mm	60 mm	10mm Axial	Verzinkt	3,0 mm	Ø 6 mm	50	50	2,05
000056170RI	70 mm	55 mm	10mm Axial	Verzinkt	3,0 mm	Ø 6 mm	50	50	1,64



Sterk vierkant scharnier verzinkt gerold met ijzeren pin

Code 29

Art. Nr.	Afm. A	Afm. B	Kleur	dikte	gaten	VE	MBH	Prijs €
000614050Z	50 mm	50 mm	Verzinkt	1,5 mm	4	24	24	1,26
000614060Z	63 mm	63 mm	Verzinkt	1,8 mm	6	12	12	1,64
000614075Z	75 mm	75 mm	Verzinkt	2,0 mm	6	12	12	2,24
000614090Z	89 mm	89 mm	Verzinkt	2,1 mm	6	12	12	3,69
000614100Z	100 mm	100 mm	Verzinkt	2,2 mm	8	12	12	4,60
000614756Z	75 mm	75 mm	Verzinkt	1,9 mm	6	24	24	2,24
000614075S	75 mm	75 mm	Zwart	2,0 mm	6	12	12	2,84



Standaard scharnier Links/Rechts 50x40 mm RVS

Code 29

Art. Nr.	Afm. A	Afm. B	Afm. C	Kleur	dikte	gaten	VE	MBH	Prijs €
010620050	50 mm	40 mm	links	RVS-V2A	1,5 mm	6	20	20	4,63
010620051	50 mm	40 mm	rechts	RVS-V2A	1,5 mm	6	20	20	4,63



Scharnier 100x100mm verzinkt sterk gerold met losse messing pin

Code 29

Art. Nr.	Afmetingen	Materiaal	VE	MBH	Prijs €
000613100Z	100x100 mm	Verzinkt	12	12	4,66



Breed scharnier 60x90 mm verzinkt staal

Code 29

Art. Nr.	Afmetingen	Materiaal	Dikte	VE	MBH	Prijs €
000704060Z	60x90 mm	Verzinkt	2 mm	20	20	3,47

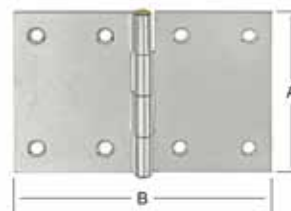

Carosseriescharnier ongeboord

Code 29

Art. Nr.	Afmetingen	Materiaal	VE	MBH	Prijs €
000012001	30 x 40 mm	IJzer	10	10	16,41
000012004	40 x 40 mm	IJzer	10	10	17,51
000012007	40 x 60 mm	IJzer	10	10	16,13
000012010	50 x 60 mm	IJzer	10	10	17,48
000012016	60 x 80 mm	IJzer	10	10	21,11
000012017	60 x 100 mm	IJzer	10	10	25,04
000012022	80 x 80 mm	IJzer	10	10	23,85



SCHARNIEREN

Kruisheng lichte uitvoering

Code 29



Art. Nr.	Afm,A1	Afm,A2	Afm,B1	afm,B2	Kleur	dikte	gaten	VE	MBH	Prijs €
000124200Z	200mm	90 mm	33 mm	50 mm	Verzinkt	2,2 mm	2/6	10	10	2,71
000124250Z	250mm	90 mm	33 mm	50 mm	Verzinkt	2,2 mm	2/6	10	10	3,15
000124300Z	300mm	90 mm	33 mm	50 mm	Verzinkt	2,2 mm	2/6	10	10	3,37
000124400Z	400mm	90 mm	33 mm	50 mm	Verzinkt	2,2 mm	2/6	10	10	4,38
000126500Z	500mm	105mm	38 mm	70 mm	Verzinkt	3,75mm	2/8	10	10	9,01
000126600Z	600mm	90 mm	38 mm	70 mm	Verzinkt	3,75mm	2/9	10	10	9,45

Kruisheng lichte uitvoering zwart

Code 29

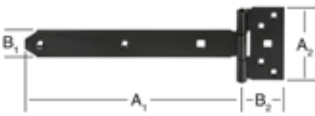

Art. Nr.	Afm,A1	Afm,A2	Afm,B1	afm,B2	Kleur	dikte	gaten	VE	MBH	Prijs €
000124200K	200mm	90 mm	33 mm	50 mm	Zwart	2,2 mm	2/6	6	6	5,23
000124250K	250mm	90 mm	33 mm	50 mm	Zwart	2,2 mm	2/6	6	6	6,05
000124400K	400mm	90 mm	33 mm	50 mm	Zwart	2,2 mm	2/6	6	6	12,00
000126500K	500 mm	105 mm	38 mm	70 mm	Zwart	3,75mm	2/8	6	6	13,58

Luikscharnier licht kleur zwart

Code 29



Art. Nr.	Afm,A1	Afm,B	Kleur	dikte	gaten	VE	MBH	Prijs €
000062200K	200mm	35 mm	Zwart	2,5 mm	1/5	6	6	4,95
000062250K	250mm	35 mm	Zwart	2,5 mm	1/5	6	6	5,51
000062300K	300mm	35 mm	Zwart	2,5 mm	1/5	6	6	5,83



Plaatduim kleine afstand doorn tot plaat

Code 29

Art. Nr.	A Doorn Ø - afstand	Afm. B	Afm. C	Kleur	gaten	VE	MBH	Prijs €
000073010Z	10 Ø / 9,3mm tot plaat	85 mm	33 mm	Verzinkt	6	10	10	1,80
000073013Z	13 Ø / 11mm tot plaat	99 mm	39 mm	Verzinkt	6	10	10	2,93
000073016Z	16 Ø / 10mm tot plaat	102 mm	40 mm	Verzinkt	6	10	10	3,34



Plaatduim kleine afstand doorn tot plaat

Code 29

Art. Nr.	A Doorn Ø - afstand	Afm. B	Afm. C	Kleur	gaten	VE	MBH	Prijs €
000073010K	10 Ø / 9,3mm tot plaat	85 mm	33 mm	Zwart	6	10	10	2,52
000073013K	13 Ø / 11mm tot plaat	99 mm	39 mm	Zwart	6	10	10	3,72

SCHARNIEREN

Plaatduim grotere afstand doorn tot plaat

Code 29

Art. Nr.	A Doorn Ø - afstand	Afm. B	Afm. C	Kleur	gaten	VE	MBH	Prijs €
000074010Z	10 Ø / 26 mm tot plaat	85 mm	33 mm	Verzinkt	6	10	10	1,67
000074013Z	13 Ø / 23mm tot plaat	103 mm	39 mm	Verzinkt	4	10	10	3,12
000074016Z	16 Ø / 23mm tot plaat	120 mm	40 mm	Verzinkt	6	10	10	3,69



Luikscharnier licht verzinkt

Code 29

Art. Nr.	Afm. A	Afm. B	voor doorn Ø	Kleur	dikte	gaten	VE	MBH	Prijs €
000065300Z	300mm	30 mm	10 mm	Verzinkt	3,5 mm	1/2	10	10	3,09
000065400Z	400mm	30 mm	10 mm	Verzinkt	3,5 mm	1/3	10	10	3,75
000065500Z	500mm	30 mm	10 mm	Verzinkt	3,5 mm	1/4	10	10	4,76
000066400Z	400mm	37mm	13 mm	Verzinkt	5,0 mm	1/3	10	10	5,36
000066500Z	500mm	37mm	13 mm	Verzinkt	5,0 mm	1/4	10	10	6,30
000066600Z	600mm	37mm	13 mm	Verzinkt	5,0 mm	1/4	10	10	7,28
000066700Z	700mm	37mm	13 mm	Verzinkt	5,0 mm	1/4	10	10	8,76



Luikscharnier licht kleur zwart

Code 29

Art. Nr.	Afm. A	Afm. B	voor doorn Ø	Kleur	dikte	gaten	VE	MBH	Prijs €
000065300K	300mm	30 mm	10 mm	Zwart	3,5 mm	1/2	6	6	5,07
000065400K	400mm	30 mm	10 mm	Zwart	3,5 mm	1/3	6	6	5,36
000066300K	300mm	37 mm	13 mm	Zwart	5,0 mm	1/2	6	6	6,49
000066400K	400mm	37mm	13 mm	Zwart	5,0 mm	1/3	6	6	7,40
000066500K	500mm	37mm	13 mm	Zwart	5,0 mm	1/4	6	6	8,41
000066600K	600mm	37mm	13 mm	Zwart	5,0 mm	1/4	6	6	9,42



Luikscharnier zwaar gewicht verzinkt

Code 29

Art. Nr.	Afm. A	Afm. B	voor doorn Ø	Kleur	dikte	gaten	VE	MBH	Prijs €
000067000Z	1000mm	45mm	16 mm	Verzinkt	5,0 mm	1/5	4	4	15,47
000067700Z	700mm	45mm	16 mm	Verzinkt	5,0 mm	1/4	10	10	9,80
000067800Z	800mm	45mm	16 mm	Verzinkt	5,0 mm	1/5	10	10	11,31



KATROLLEN

Katrol met schroef verzinkt staal

Code 29

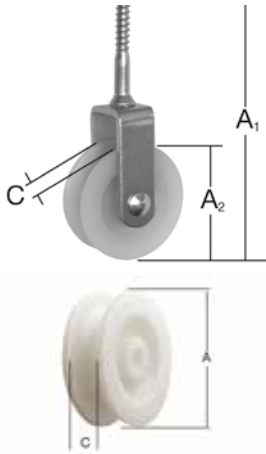

Art. Nr.	A1	A2	C	Verpakking	VE	MBH	Prijs €
007900190AV	90 mm	30 mm	6 mm	Kaart met 1 st.	5	5	2,39
007900191AV	120 mm	50 mm	8 mm	Kaart met 1 st.	5	5	3,37

Polyamiderol voor katrol met touw van 8 mm doorsnede

Code 29

Art. Nr.	A	C	Verpakking	VE	MBH	Prijs €
007900192AV	50 mm	8 mm	Kaart met 2 st.	5	5	3,94

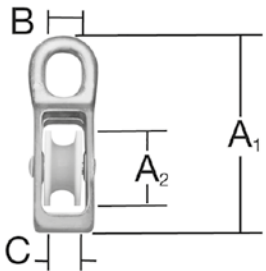

Katrol enkel 7/9/12 mm touwdikte verzinkt staal

Code 29

Art. Nr.	A1	A2	B	C	Verpakking	VE	MBH	Prijs €
007900227AV	70mm	25mm	12mm	7mm	Kaart met 1 st.	5	5	2,90
007900228AV	93mm	40mm	14mm	9mm	Kaart met 1 st.	5	5	5,36
007900229AV	130 mm	50mm	15mm	12mm	Kaart met 1 st.	5	5	8,19

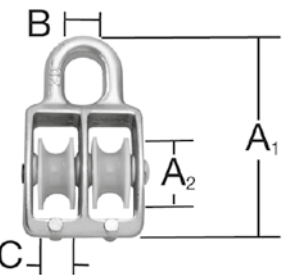

Katrol dubbel voor touw van 6/8 mm dik verzinkt staal

Code 29

Art. Nr.	A1	A2	B	C	Verpakking	VE	MBH	Prijs €
007900230AV	60mm	20mm	11mm	6mm	Kaart met 1 st.	5	5	3,02
007900231AV	80mm	30mm	13mm	8mm	Kaart met 1 st.	5	5	5,70

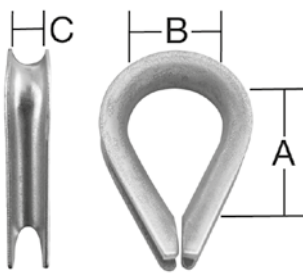

Puntkous verzinkt staal

Code 29

Art. Nr.		A	B	C	Verpakking	Aantal	VE	MBH	Prijs €
007900206AV	Verzinkt	21,5	13	4,0	Kaart met 2 st.	2	5	5	1,04
007900207AV	Verzinkt	30,0	14	6,0	Kaart met 2 st.	2	5	5	1,20
007900208AV	Verzinkt	39,0	18	9,0	Kaart met 2 st.	2	5	5	1,58
007900209AV	Verzinkt	47,5	22	11,0	Kaart met 2 st.	2	5	5	1,73
007900210AV	Verzinkt	61,0	28	14,0	Kaart met 2 st.	2	5	5	3,06

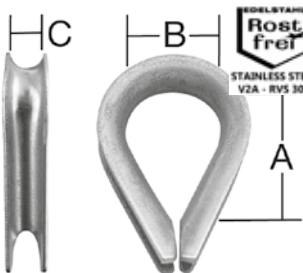

Art. Nr.		A	B	C	Verpakking	Aantal	VE	MBH	Prijs €
007900786AV	RVS-V2A	16	9	2	Kaart met 2 st.	2	5	5	1,20
007900787AV	RVS-V2A	17,5	11	4	Kaart met 2 st.	2	5	5	1,54
007900788AV	RVS-V2A	21	13	5	Kaart met 2 st.	2	5	5	1,45
007900789AV	RVS-V2A	24	14	6	Kaart met 2 st.	2	5	5	1,95

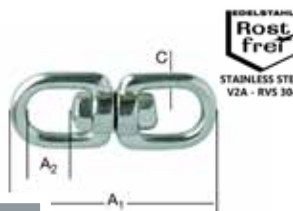

Draaikoppeling met twee ogen RVS

Code 29

Art. Nr.		A1	A2	C	Verpakking	VE	MBH	Prijs €
007900810AV	RVS-V2A	60	13	5	Kaart met 2 st.	5	5	10,52

KABELKLEMMEN

Kabelklemmen

Code 29

Art. Nr.		C1	C2	Verpakking	VE	MBH	Prijs €
007900200AV	Verzinkt	3mm	M4	Kaart met 2 st.	5	5	0,95
007900201AV	Verzinkt	5mm	M5	Kaart met 2 st.	5	5	1,04
007900202AV	Verzinkt	6mm	M5	Kaart met 2 st.	5	5	1,07
007900203AV	Verzinkt	8mm	M6	Kaart met 2 st.	5	5	1,35
007900204AV	Verzinkt	10mm	M8	Kaart met 2 st.	5	5	1,86
007900205AV	Verzinkt	13mm	M10	Kaart met 2 st.	5	5	2,96



Code 29

Art. Nr.		C1	C2	Verpakking	VE	MBH	Prijs €
007900790AV	RVS-V2A	3mm	M4	Kaart met 2 st.	5	5	4,32
007900791AV	RVS-V2A	4mm	M4	Kaart met 2 st.	5	5	4,00
007900792AV	RVS-V2A	5mm	M5	Kaart met 2 st.	5	5	3,84
007900793AV	RVS-V2A	6mm	M6	Kaart met 2 st.	5	5	4,16



D-sluiting met schroef

Code 29

Art. Nr.		A	B	C	Aantal	VE	MBH	Prijs €
007900220AV	Verzinkt	20mm	10mm	5mm	Kaart met 2 st.	5	5	1,48
007900221AV	Verzinkt	32mm	16mm	8mm	Kaart met 2 st.	5	5	1,20
007900222AV	Verzinkt	44mm	22mm	11mm	Kaart met 2 st.	5	5	2,33
007900223AV	Verzinkt	56 mm	28mm	14mm	Kaart met 2 st.	5	5	3,24

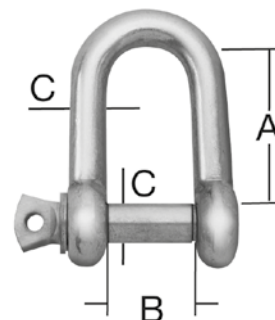

D-Sluiting met schroef RVS

Code 29

Art. Nr.		A	B	C	Aantal	VE	MBH	Prijs €
007900776AV	RVS-V2A	14mm	8mm	4mm	Kaart met 2 st.	5	5	4,32
007900777AV	RVS-V2A	17,5mm	10mm	5mm	Kaart met 2 st.	5	5	4,06
007900778AV	RVS-V2A	21mm	12mm	6mm	Kaart met 2 st.	5	5	2,58

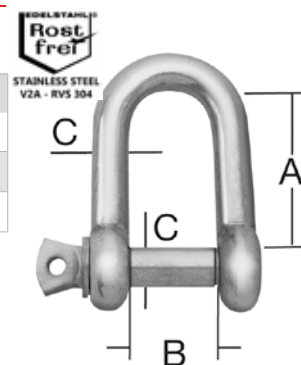

Schroefverbinder

Code 29

Art. Nr.		A1	A2	B	C	Aantal	VE	MBH	Prijs €
007900260AV	Verzinkt	29mm	5mm	10mm	3,5mm	Kaart met 2 st.	5	5	1,64
007900261AV	Verzinkt	38mm	6,5mm	13mm	5mm	Kaart met 2 st.	5	5	1,92
007900262AV	Verzinkt	45mm	7,5mm	14mm	6mm	Kaart met 1 st.	5	5	1,48
007900263AV	Verzinkt	60mm	10mm	18mm	8mm	Kaart met 1 st.	5	5	1,98
007900264AV	Verzinkt	69mm	12mm	20mm	10mm	Kaart met 1 st.	5	5	2,71

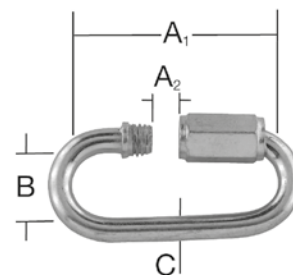

Code 29

Art. Nr.		A1	A2	B	C	Aantal	VE	MBH	Prijs €
007900779AV	RVS-V2A	25mm	5mm	10mm	3,5m	Kaart met 1 st.	5	5	2,05
007900780AV	RVS-V2A	31,5mm	5,5mm	11mm	4mm	Kaart met 1 st.	5	5	2,05
007900781AV	RVS-V2A	38,5mm	6mm	13mm	5mm	Kaart met 1 st.	5	5	2,65

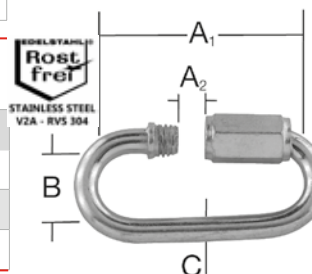

SPANNERS EN HAKEN

Spanner met haak en oog verzinkt staal

Code 29

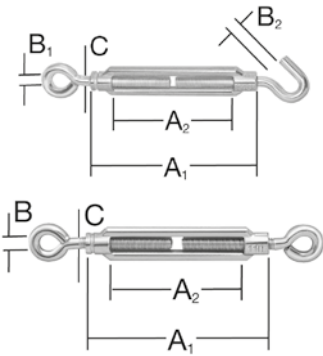

Art. Nr.			A1	A2	B1	B2	C	Verpakking	VE	MBH	Prijs €
007900224AV	oog+haak	Verzinkt	50	30	8	6	M5	Kaart met 2 st.	5	5	2,52
007900236AV	oog+haak	Verzinkt	110	75	10	10	M8	Kaart met 2 st.	5	5	5,92
007900237AV	oog+haak	Verzinkt	120	90	12	12	M10	Kaart met 2 st.	5	5	7,84
007900225AV	oog+oog	Verzinkt	100	70	10	10	M6	Kaart met 1 st.	5	5	2,30
007900226AV	oog+oog	Verzinkt	110	80	10	10	M8	Kaart met 1 st.	5	5	3,72
007900783AV	oog+oog	RVS-V2A	70	52	8	8	M5	Kaart met 1 st.	5	5	4,28
007900784AV	oog+haak	RVS-V2A	90	68	10	10	M6	Kaart met 1 st.	5	5	6,08
007900785AV	oog+oog	RVS-V2A	90	68	10	10	M6	Kaart met 1 st.	5	5	5,36

Spiraalhaak houtschroef 180x10,6 mm verzinkt staal

Code 29



Art. Nr.	A	C	Verpakking	VE	MBH	Prijs €
007900251AV	180mm	10,6mm	Kaart met 2 st.	5	5	11,66

Spiraalhaak metrische schroefdraad M12 180x10,6 mm verzinkt staal

Code 29

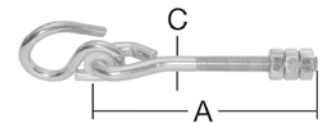

Art. Nr.	A	C	Verpakking	VE	MBH	Prijs €
007900252AV	180mm	10,6mm	Kaart met 2 st.	5	5	14,24

Plafondhaak met houtschroefdraad verzinkt staal 145x8,9 mm

Code 29

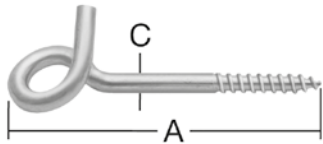

Art. Nr.	A	C	Verpakking	VE	MBH	Prijs €
007900246AV	145mm	8,9mm	Kaart met 2 st.	5	5	4,28

Plafondhaak met metrische schroefdraad M10 verzinkt staal 145x8,9 mm

Code 29

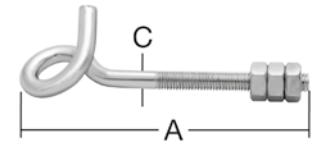

Art. Nr.	A	C	Verpakking	VE	MBH	Prijs €
007900247AV	145mm	8,9mm	Kaart met 2 st.	5	5	4,19

Schommelhaak met uitschiet beveiliging +hout schroefdraad verzinkt

Code 29

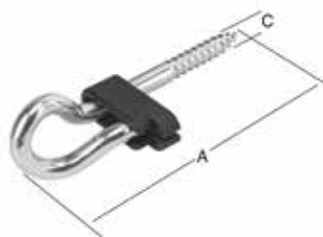

Art. Nr.		A	C	Verpakking	VE	MBH	Prijs €
007900766AV	houtschroefdraad	150mm	10,6mm	Kaart met 2 st.	5	5	14,99

Code 29

Art. Nr.	Afmeting+ schroef	A	C	Verpakking	VE	MBH	Prijs €
007900767AV	metrische schroefdraad M12	150mm	10mm	Kaart met 2 st.	5	5	20,10

Ring verzinkt staal

Code 29

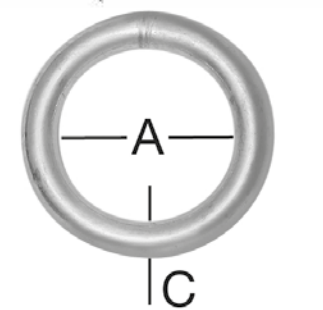

Art. Nr.	A	C	Verpakking	VE	MBH	Prijs €
007900248AV	ø 40mm	8mm	Kaart met 2 st.	5	5	2,17
007900249AV	ø 35mm	7mm	Kaart met 2 st.	5	5	1,70

D-ring voor riemen tot 25 mm verzinkt staal

Code 29

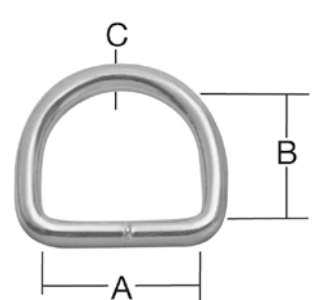

Art. Nr.				Verpakking	VE	MBH	Prijs €
007900234AV	25mm	22mm	5mm	Kaart met 1 st.	5	5	1,04

SPANNERS EN HAKEN

Karabijnhaak

Code 29

Art. Nr.		A	B1	B2	C	Verpakking	VE	MBH	Prijs €
007900211AV	Verzinkt	50	7	5	5	Kaart met 2 st.	5	5	1,42
007900212AV	Verzinkt	60	8	6	6	Kaart met 1 st.	5	5	1,04
007900213AV	Verzinkt	80	12	9	8	Kaart met 1 st.	5	5	1,29
007900214AV	Verzinkt	100	15	11	10	Kaart met 1 st.	5	5	1,76
007900215AV	Verzinkt	120	16	12	11	Kaart met 1 st.	5	5	2,24

Code 29

Art. Nr.		A	B1	B2	C	Verpakking	VE	MBH	Prijs €
007900794AV	RVS-V2A	50	8	5,5	5	Kaart met 2 st.	5	5	3,94
007900795AV	RVS-V2A	60	8,5	6,5	6	Kaart met 2 st.	5	5	4,57
007900796AV	RVS-V2A	70	10	7,5	7	Kaart met 1 st.	5	5	3,12
007900797AV	RVS-V2A	80	11,5	7,5	8	Kaart met 1 st.	5	5	4,19
007900798AV	RVS-V2A	100	16	11	10	Kaart met 1 st.	5	5	6,62



Karabijnhaak met schroefsluiting verzinkt staal

Code 29

Art. Nr.	Afmetingen	A	B1	B2	C	Verpakking	VE	MBH	Prijs €
007900232AV	Verzinkt	70	10	7	7	Kaart met 1 st.	5	5	1,45

Sleephaak 92x18 mm draaglast tot 875 kg verzinkt staal

Code 29

Art. Nr.	A	B	Verpakking	VE	MBH	Prijs €
007900239AV	92mm	18mm	Kaart met 1 st.	5	5	4,22

Laadhaak 89x12x18 mm draaglast tot 250 kg verzinkt staal

Code 29

Art. Nr.	A	B1	B2	Verpakking	VE	MBH	Prijs €
007900240AV	89mm	12mm	18mm	Kaart met 1 st.	5	5	4,82

Kettingverbinder voor nood verzinkt staal

Code 29

Art. Nr.	A	B	C	Verpakking	VE	MBH	Prijs €
007900265AV	17	7	3	Kaart met 2 st.	5	5	0,95
007900266AV	19	8	4	Kaart met 2 st.	5	5	1,70
007900267AV	27	9,5	5	Kaart met 2 st.	5	5	1,51
007900268AV	30	10	6	Kaart met 2 st.	5	5	1,80
007900269AV	38	15	8	Kaart met 2 st.	5	5	3,78

Hangmathaak verzinkt met hout schroefdraad

Code 29

Art. Nr.	A	C	Verpakking	VE	MBH	Prijs €
007900298AV	75mm	9.5mm	Kaart met 1 st.	5	5	3,06

Hangmathaak verzinkt opschroefbaar

Code 29

Art. Nr.	A	B1	B2	C	Verpakking	VE	MBH	Prijs €
007900299AV	68	45	5-6	9.5	Kaart met 1 st.	5	5	2,93

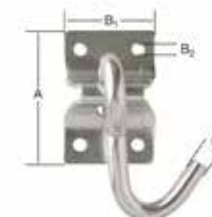
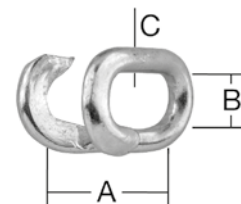
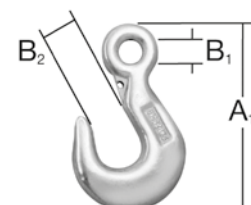
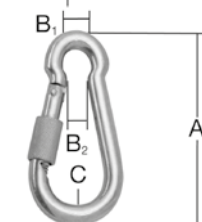
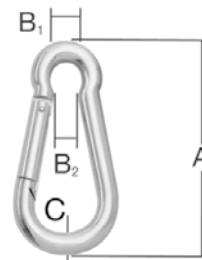
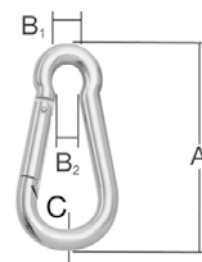

SPANNERS EN HAKEN

Simplexhaak met roteerbaar oog vernikkeld staal

Code 29

Art. Nr.	A1	A2	Verpakking	VE	MBH	Prijs €
007900244AV	39mm	71mm	Kaart met 2 st.	5	5	1,42
007900245AV	59mm	95mm	Kaart met 2 st.	5	5	1,89

Karabijnhaak vernikkeld staal

Code 29

Art. Nr.	A	B	Verpakking	VE	MBH	Prijs €
007900242AV	55mm	11mm	Kaart met 2 st.	5	5	1,64
007900243AV	82mm	20mm	Kaart met 2 st.	5	5	1,98

Karabijnhaak voor riemen tot 25 mm vernikkeld

Code 29

Art. Nr.	A	B	Verpakking	VE	MBH	Prijs €
007900258AV	80mm	26mm	Kaart met 1 st.	5	5	2,87

Karabijnhaak met sleutelring vernikkeld

Code 29

Art. Nr.	A	B1	B2	Verpakking	VE	MBH	Prijs €
007900758AV	60mm	13mm	2mm	Kaart met 1 st.	5	5	1,95

Tasketting vernikkeld

Code 29

Art. Nr.	A1	A2	Verpakking	VE	MBH	Prijs €
007900291AV	54mm	480mm	Kaart met 1 st.	5	5	3,78

Duplexklem verzinkt

Code 29

Art. Nr.	C	B	Verpakking	VE	MBH	Prijs €
007900752AV	2mm	M4	Kaart met 2 st.	5	5	1,13
007900753AV	3mm	M4	Kaart met 2 st.	5	5	1,13
007900754AV	4mm	M5	Kaart met 2 st.	5	5	1,48
007900755AV	5mm	M6	Kaart met 2 st.	5	5	1,58

Kogelketting huls voor rolgordijnen verchromd

Code 29

Art. Nr.	C	Verpakking	VE	MBH	Prijs €
007900273AV	2,8mm - 3,0mm	Kaart met 4 st.	5	5	1,42

Beugel voor kogelketting messing vernikkeld 2,8-3,6 mm

Code 29

Art. Nr.	Kettingdikte	Verpakking	VE	MBH	Prijs €
007900271AV	2,8-3,6 mm	Kaart met 4 st.	5	5	1,45

SPANNERS EN HAKEN

S-haak verzinkt staal

Code 29

Art. Nr.	A	B	C	Verpakking	VE	MBH	Prijs €
007900253AV	19	4	3mm	Kaart met 2 st.	5	5	0,72
007900254AV	26	5,5	4mm	Kaart met 2 st.	5	5	0,85
007900255AV	43	10	6mm	Kaart met 2 st.	5	5	1,42
007900256AV	35	8	5mm	Kaart met 2 st.	5	5	1,23

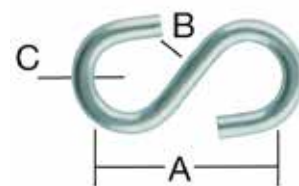

S-Haak roestvrij staal

Code 29

Art. Nr.	A	B	C	Verpakking	VE	MBH	Prijs €
007900700AV	27	5,5	4	Kaart met 2 st.	5	5	1,95



Decor-S-haak zwart

Code 29

Art. Nr.	A	B	C	Verpakking	VE	MBH	Prijs €
007900288AV	31,5	6	3,8	Kaart met 2 st.	5	5	1,92



Vleeshaak RVS (V2A)

Code 29

Art. Nr.	A	B	C	Verpakking	VE	MBH	Prijs €
007900759AV	140	30	5,0	Kaart met 1 st.	5	5	2,96

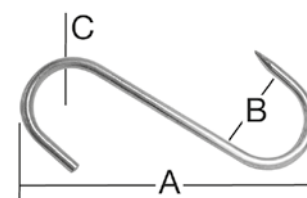

S-haak + Ring vernikkeld

Code 29

Art. Nr.	A	B	C	Verpakking	VE	MBH	Prijs €
007900277AV	30	20	3	Kaart met 2 st.	5	5	1,45



Waslijnhaak verzinkt/wit

Code 29

Art. Nr.	Afwerking	A	B	C	Verpakking	VE	MBH	Prijs €
007900284AV	verzinkt	65	22	4,7	Kaart met 2 st.	5	5	1,23
007900285AV	wit	65	22	4,7	Kaart met 2 st.	5	5	1,89
007900294AV	verzinkt	100	25	5,8	Kaart met 2 st.	5	5	2,11

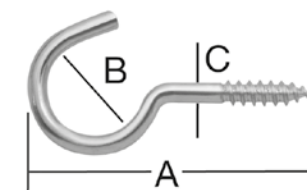

Ringschroef verzinkt

Code 29

Art. Nr.	A	B	C	Verpakking	VE	MBH	Prijs €
007900292AV	80	22	7,8	Kaart met 2 st.	5	5	2,55
007900760AV	100	22	7,8	Kaart met 2 st.	5	5	2,61

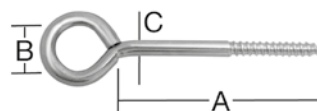

Spanschroef verzinkt staal

Code 29

Art. Nr.	A1	A2	B	C	Verpakking	VE	MBH	Prijs €
007900217AV	100	80	10	6	Kaart met 2 st.	5	5	1,83
007900218AV	150	90	10	6	Kaart met 2 st.	5	5	2,78
007900219AV	150	90	10	8	Kaart met 2 st.	5	5	4,58

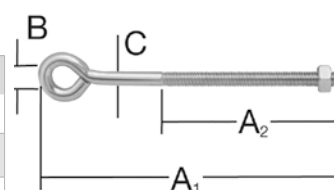

R clip eenvoudig type

Code 29

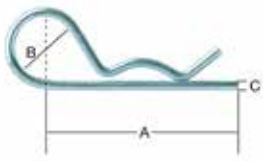

Art. Nr.	A	B	C	Verpakking	VE	MBH	Prijs €
007900800AV	50	10	2	Kaart met 3 st.	5	5	1,10
007900802AV	60	20	4	Kaart met 2 st.	5	5	1,17
007900803AV	85	24	5	Kaart met 2 st.	5	5	1,70
007900804AV	105	30	6	Kaart met 1 st.	5	5	1,58

Borgpin verzinkt

Code 29

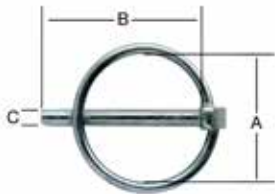

Art. Nr.	A	B	C	Verpakking	VE	MBH	Prijs €
007900820AV	34	34	4,5	Kaart met 2 st.	5	5	1,67
007900821AV	41	42	6	Kaart met 2 st.	5	5	1,76
007900823AV	41	42	8	Kaart met 2 st.	5	5	2,33
007900825AV	41	42	10	Kaart met 2 st.	5	5	2,27

Ei-vormige touwklem

Code 29



Art. Nr.	A	C	Verpakking	VE	MBH	Prijs €
007900830AV	28	2	Kaart met 2 st.	5	5	3,75
007900832AV	34	4	Kaart met 2 st.	5	5	5,73
007900834AV	35	6	Kaart met 2 st.	5	5	9,45

Klemkous Aluminium

Code 29

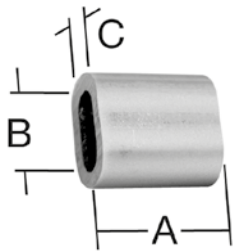

Art. Nr.	A	B	C	Verpakking	VE	MBH	Prijs €
007900761AV	7	4,5	2	Kaart met 10 st.	5	5	1,54
007900762AV	9	5	2,5	Kaart met 10 st.	5	5	1,64
007900763AV	11	6,5	3	Kaart met 6 st.	5	5	1,42
007900764AV	14	9	4	Kaart met 6 st.	5	5	1,70

Steeksluiting kunststof voor riemen

Code 29

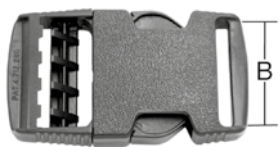

Art. Nr.	B	Kleur	Verpakking	VE	MBH	Prijs €
007904929AV	riemen tot 25 mm	zwart	Kaart met 1 st.	5	5	2,93
007904930AV	riemen tot 40 mm	zwart	Kaart met 1 st.	5	5	3,50

Insteeksluiting voor riemen tot 25 mm

Code 29



Art. Nr.	Riendikte	Kleur	Verpakking	VE	MBH	Prijs €
007904931AV	riemen tot 25 mm	zwart	Kaart met 1 st.	5	5	1,73

Gesp voor riemen tot 25 mm verzinkt staal

Code 29



Art. Nr.	Riendikte	Verzinkt	Verpakking	VE	MBH	Prijs €
007900233AV	Riemen tot 25 mm	Verzinkt	Kaart met 1 st.	5	5	2,11

Steeksluiting voor riem kunststof

Code 29



Art. Nr.	Riendikte	Kleur	Verpakking	VE	MBH	Prijs €
007904933AV	Riemen tot 25mm	zwart	Kaart met 1 st.	5	5	2,17
007904934AV	Riemen tot 40mm	zwart	Kaart met 1 st.	5	5	4,25

Verstelring voor riemen kunststof

Code 29



Art. Nr.	Riendikte	Kleur	Verpakking	VE	MBH	Prijs €
007904935AV	Riemen tot 25 mm	zwart	Kaart met 1 st.	5	5	1,58
007904936AV	Riemen tot 30 mm	zwart	Kaart met 1 st.	5	5	2,11

TOUWEN/KETTINGEN/ACCESSOIRES

Afzetlint rood wit 80 mm dik

Code 29

Art. Nr.	Afmetingen	Kleur	VE	MBH	Prijs €
007901521AV	Dikte: 80 mm Lengte: 50 m	rood/wit	10	10	8,41
007901522AV	Dikte: 80 mm Lengte 500 m	rood/wit	1	1	32,92



Afzetlint 50 mm 66 meter lang

Code 29

Art. Nr.	Afmetingen	Kleur	VE	MBH	Prijs €
007901525AV	Dikte: 50 mm Lengte: 66 meter	geel zwart	6	6	4,41
007901526AV	Dikte: 50 mm Lengte: 66 meter	rood wit	6	6	4,41



Afzetketting kunststof rood-wit

Code 29

Art. Nr.		A	B	C	Breekpunt	Belastbaar	Spoel maat	gewicht	Lengte	VE	MBH	Prijs €
008044060RW	kunststof	40	21	6	-	-	-	1,5kg	5 m	5	5	7,75
007901519AV	kunststof	40	21	6	-	-	-	1,5kg	25 m	1	1	28,60
007901520AV	kunststof	63	28	8	-	-	-	2,6kg	25 m	1	1	39,56
008206060RW	Staal	42	22,8	6	1280kg	160kg	-	8,8kg	15 m	15	15	5,73



Ronde staalketting verzinkt vorm C = (gelaste lange schakels)

Code 29

Art. Nr.	A	B	C	Breekpunt	Spoel maat	Belastbaar	gewicht	Lengte	VE	MBH	Prijs €
008200030Z	26	11,4	3	360kg	250x80	45kg	5.12 kg	30m	30	30	1,29
008200040Z	32	15,2	4	640kg	250x180	80kg	16,4kg	60m	60	60	1,92
008200050Z	35	19,0	5	1000kg	250x180	125kg	11,3kg	30m	30	30	2,93
008200060Z	42	22,8	6	1600kg	250x180	200kg	13.9kg	25m	25	25	4,32
008200070Z	49	26,6	7	2400kg	250x180	300kg	12,5kg	15m	15	15	5,99
008200080Z	52	30,4	8	3200kg	250x180	400kg	10,5kg	10m	10	10	7,91

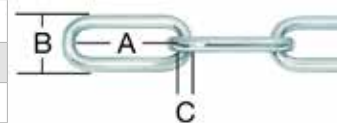

Ronde staalketting verzinkt vorm A = (gelaste korte schakels)

Code 29

Art. Nr.	A	B	C	Breekpunt	Belastbaar	Spoel maat	lengte	gewicht	VE	MBH	Prijs €
008201020Z	12	7,6	2	240kg	30kg	60x80	60m	4.5kg	60	60	0,76
008201030Z	16	11,4	3	360kg	45kg	30x80	30m	5.4kg	30	30	1,48
008201040Z	19	15,2	4	800kg	100kg	60x80	60m	17.6kg	60	60	2,21
008201060Z	24	22,8	6	1600kg	200kg	25x180	25m	16,9kg	25	25	5,10
008201080Z	32	30,4	8	3200kg	400kg	10x180	10m	11,5kg	10	10	9,32



Ronde staalketting vorm A gedraaid verzinkt = (gelaste korte schakels)

Code 29

Art. Nr.	A	B	C	Breekpunt	Belastbaar	Spoel maat	lengte	gewicht	VE	MBH	Prijs €
008202030Z	16	11,4	3	200kg	40kg	250x80	30m	5,2kg	30	30	2,24
008202040Z	19	15,2	4	400kg	80kg	250x80	50m	15,1kg	50	50	3,15
008202050Z	21	19,0	5	625kg	125kg	250x80	30m	15,0kg	30	30	4,28



Ronde staalketting vorm A = (gelaste korte schakels) DIN766

Code 29

Art. Nr.	A	B	C	Breekpunt	Belastbaar	Spoel maat	lengte	gewicht	VE	MBH	Prijs €
008203050Z	18,5	17,5	5	2000kg	250kg	30x80	30m	14,4kg	30	30	3,84
008204020Z	12	9,7	2	125kg	25kg	60x80	60m	4,6kg	60	60	1,32



TOUWEN/KETTINGEN/ACCESSOIRES

Knoopketting verzinkt

Code 29



Art. Nr.	A	B	C	Breekpunt	Belastbaar	Spoel maat	lengte	gewicht	VE	MBH	Prijs €
008207016Z	23	7	1,6	110kg	22kg	250x80	60m	3,6kg	60	60	0,79
008207020Z	28	9	2,0	200kg	40kg	250x80	50m	4,9kg	50	50	0,91
008207025Z	35	11	2,5	350kg	70kg	250x80	30m	4,1kg	30	30	1,17

Kogelketting messing verchroomd

Code 29



Art. Nr.	A	B	C	Breekpunt	Belastbaar	Spoel maat	lengte	gewicht	VE	MBH	Prijs €
008210036MSC	-	-	3,6	11kg	2kg	90x80	25m	0,5kg	25	25	2,30

Kroonluchterketting messing verchroomd

Code 29



Art. Nr.	A	B	C	Breekpunt	Belastbaar	Spoel maat	lengte	gewicht	VE	MBH	Prijs €
008211004MSC	-	-	0,4	44kg	14kg	90x80	25m	0,5kg	25	25	3,34

Klokketting vernikkeld

Code 29

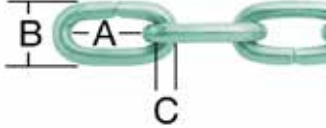

Art. Nr.	A	B	C	Breekpunt	Belastbaar	Spoel maat	lengte	gewicht	VE	MBH	Prijs €
008209011N	7	4,5	1,1	8kg	2kg	90x80	50m	1,11kg	50	0,85	1,32
008209016N	8	6,0	1,6	24kg	7kg	90x80	25m	1,15kg	25	1,07	

Klokketting messing

Code 29



Art. Nr.	A	B	C	Breekpunt	Belastbaar	Spoel maat	lengte	gewicht	VE	MBH	Prijs €
008209011V	7,0	4,5	1,1	8kg	2kg	90x80	50m	1,10kg	50	50	1,42
008209013V	7,5	5,0	1,3	14kg	4kg	90x80	25m	1,11kg	25	25	1,23
008209016V	8,0	6,0	1,6	24kg	7kg	90x80	25m	1,15kg	25	25	1,76

Sierketting koper beruineerd vierkant gehamerd

Code 29

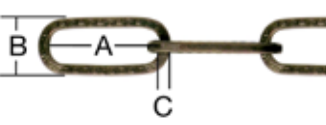

Art. Nr.	A	B	C	Breekpunt	Belastbaar	Spoel maat	lengte	gewicht	VE	MBH	Prijs €
008216020KUBR	17	10	2,0	27kg	10kg	90x80	10m	0,76kg	10	10	2,11
008216030KUBR	29	15	3,0	64kg	20kg	90x80	25m	3,80kg	25	25	3,15

Sierketting vernikkeld vierkant gehamerd

Code 29

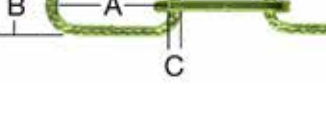

Art. Nr.	A	B	C	Breekpunt	Belastbaar	Spoel maat	lengte	gewicht	VE	MBH	Prijs €
008216020V	17	10	2,0	27kg	10kg	90x80	10m	0,75kg	10	10	1,92
008216030V	29	15	3,0	64kg	20kg	90x80	25m	3,95kg	25	25	3,31

Sierketting zwart gebrand vierkant gehamerd

Code 29



Art. Nr.	A	B	C	Breekpunt	Belastbaar	Spoel maat	lengte	gewicht	VE	MBH	Prijs €
008216030SGB	29	15	3,0	64kg	20kg	90x80	25m	3,85kg	25	25	2,68

Sierketting zwart gebrand gedraaid en gehamerd

Code 29

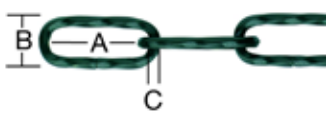

Art. Nr.	A	B	C	Breekpunt	Belastbaar	Spoel maat	lengte	gewicht	VE	MBH	Prijs €
008217038SGB	38	20	3,8	110kg	22kg	250x80	15m	3,80kg	15	15	3,50

Sierketting vernikkeld

Code 29

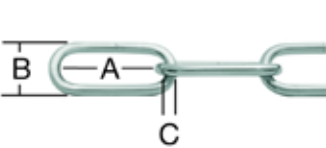

Art. Nr.	A	B	C	Breekpunt	Belastbaar	Spoel maat	lengte	gewicht	VE	MBH	Prijs €
008215020N	16	10	2,0	20kg	7kg	90x80	10m	0,72kg	10	10	1,64
008215028N	34	16	2,8	30kg	10kg	250x80	30m	3,75kg	30	30	2,30

Sierketting messing

Code 29

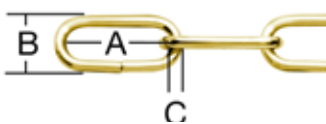

Art. Nr.	A	B	C	Breekpunt	Belastbaar	Spoel maat	lengte	gewicht	VE	MBH	Prijs €
008215020V	16	10	2,0	20kg	7kg	90x80	10m	0,72kg	10	10	1,73

POS AFGESTEMD OP UW WENSEN

De informatieve pictogrammen boven de presentaties zijn verdere middelen op het POS om de klant met succes aan te spreken en hem, indien nodig, gebruiksvoorbeelden te geven. Naargelang van het produktassortiment ontvangen onze klanten brochures, waarvan sommige ook geïllustreerd zijn en die meestal alle produkten van het gamma bevatten. VORMANN probeert het vaak zonder (veel) woorden te doen, enerzijds om de klant niet te overladen met vaak overbodige informatie en anderzijds zodat de flyers geschikt zijn voor internationaal gebruik.

Goederen om aan te raken

Als het passend is en in de presentatie kan worden geïntegreerd, kunnen ook toepassingsmodellen en monsters worden bijgevoegd, die de klant eveneens aanspreken en de aankoopbeslissing vergemakkelijken.

Presentatie van goederen in de CI van de klant

Tot ons POS-concept behoort ook het op verzoek leveren van goederen in klantspecifieke "eigen presentatie", Neem contact met ons op en laat ons u een concept voorstellen!

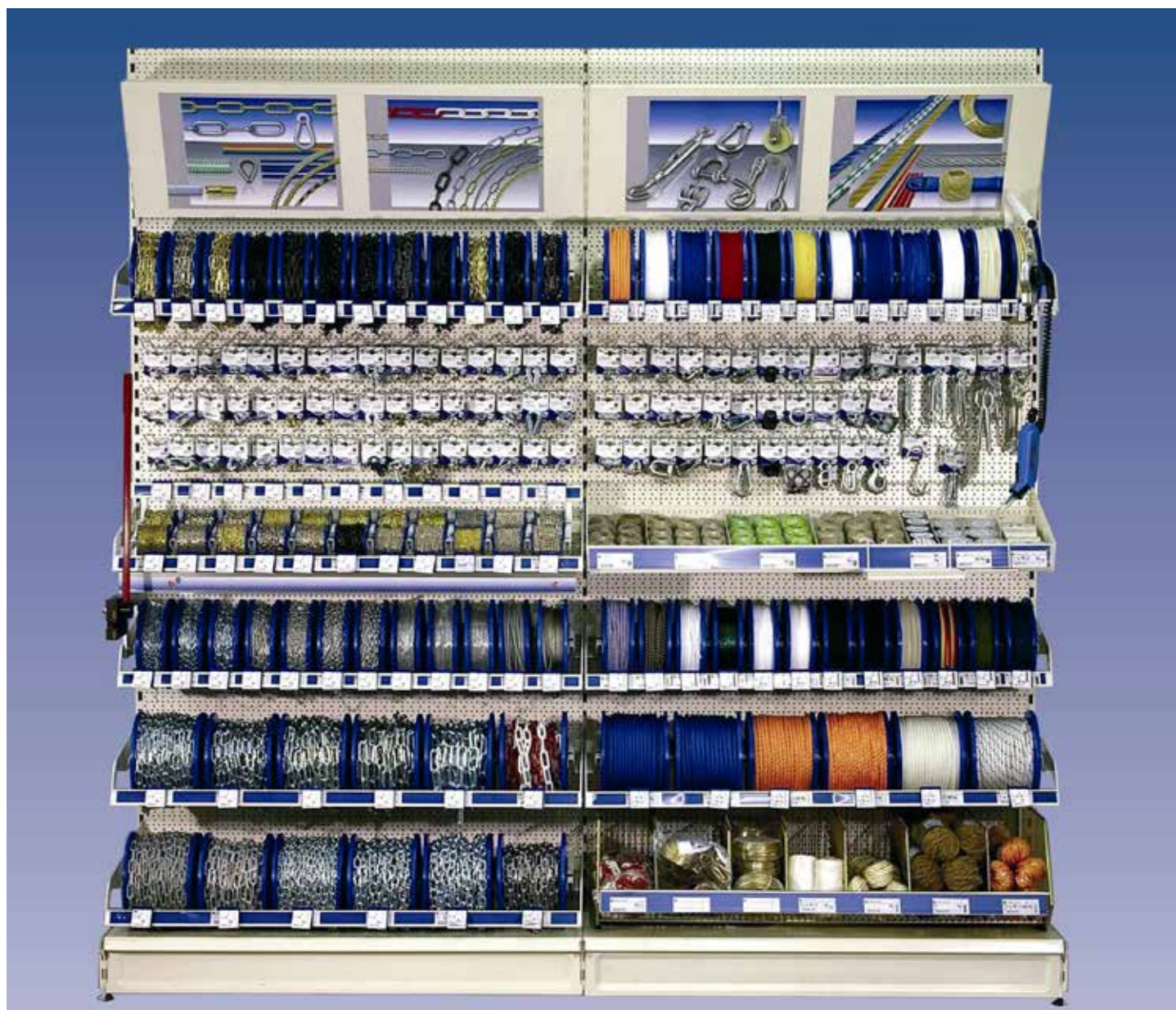

TOUWEN/KETTINGEN/ACCESSOIRES

Touw middelsterk sisal 275 meter

Code 29



Art. Nr.	Touwlengte	Kleur	VE	MBH	Prijs €
007901953AV	275 m	Natuur	6	6	23,81

8 mm sisaltouw 15 meter lang

Code 29



Art. Nr.	Afmetingen	VE	MBH	Prijs €
007901514AV	Dikte: 8 mm Lengte: 15 m	10	10	14,46

Boombindtouw kokosvezel 12 meter

Code 29



Art. Nr.	Afmetingen	VE	MBH	Prijs €
007901515AV	12 Meter	10	10	7,12

Metselaarstouw fluoriserend polypropyleen

Code 29



Art. Nr.	Afmetingen	Kleur	VE	MBH	Prijs €
008002020GNF	Dikte: 2mm Lengte: 100 m	groen	6	6	9,80
008002020PIF	Dikte: 2mm Lengte: 100 m	roze	6	6	9,80
008002020	Dikte: 2 mm Lengte: 100 m	groen	6	6	4,69

Polypropyleen verpakkingtouw 350 mm wit

Code 29



Art. Nr.	Lengte	Kleur	VE	MBH	Prijs €
007901956AV	500g 350 mm	wit	1	1	11,43

Decoratie snoer plastic transparant 100 meter

Code 29



Art. Nr.	Afmetingen	Kleur	VE	MBH	Prijs €
007904060AV	Dikte: 0,35mm Lengte: 100 m	wit	12	12	1,67
007904061AV	Dikte: 0,5mm Lengte: 100 m	wit	12	12	1,83
007904062AV	Dikte: 1,0mm Lengte: 100 m	wit	12	12	7,56

Kunstvezel-bindtouw polypropyleen groen-geel

Code 29



Art. Nr.	Afmeting	Kleur	VE	MBH	Prijs €
007900012AV	50 m	groen-geel	10	10	1,70

Kunstvezel-bindtouw polypropyleen natuurlijke kleur

Code 29



Art. Nr.	Afmeting	Kleur	VE	MBH	Prijs €
007900014AV	40 m	natuur	12	12	1,35

TOUWEN/KETTINGEN/ACCESSOIRES

Gevlochten schootlijn Polypropyleen blauw

Code 29

Art. Nr.	C	Breekpunt	Belastbaar	Spoel maat	lengte	gewicht	kleur	VE	MBH	Prijs €
008400080BL	8	880kg	110kg	250x180	100m	3,77kg	blauw	100	100	0,60
008400100BL	10	1300kg	160kg	250x180	70m	3,47kg	blauw	70	70	0,98
008400120BL	12	1760kg	220kg	250x180	60m	4,37kg	blauw	60	60	1,32
008400140BL	14	2400kg	300kg	250x180	50m	4,57kg	blauw	50	50	2,24



Schootlijn gevlochten polypropyleen wit-blauw

Code 29

Art. Nr.	C	Breekpunt	Belastbaar	Spoel maat	lengte	gewicht	kleur	VE	MBH	Prijs €
008401080WSBL	8	880kg	110kg	250x180	100m	2,91kg	Wit - blauw	100	100	0,54
008401100WSBL	10	1300kg	160kg	250x180	70m	3,28kg	Wit - blauw	70	70	0,82
008401120WSBL	12	1760kg	220kg	250x180	60m	4,08kg	Wit - blauw	60	60	1,13



Schootlijn gevlochten polypropyleen gekleurd

Code 29

Art. Nr.	C	Breekpunt	Belastbaar	Spoel maat	lengte	gewicht	kleur	VE	MBH	Prijs €
008401080WSR	8	880kg	110kg	250x180	100m	2,91kg	gekleurd	100	100	0,54
008401100WSR	10	1300kg	160kg	250x180	70m	3,28kg	gekleurd	70	70	0,82
008401120WSR	12	1760kg	220kg	250x180	60m	4,08kg	gekleurd	60	60	1,17



Touw rondgevlochten polypropyleen

Code 29

Art. Nr.	C	Breekpunt	Belastbaar	Spoel maat	lengte	gewicht	kleur	VE	MBH	Prijs €
008403030BL	3	130kg	16kg	250x80	300m	1,26kg	blauw	300	300	0,13
008403040BL	4	220kg	27kg	250x80	200m	1,38kg	blauw	200	200	0,19
008403060BL	6	480kg	60kg	250x80	80m	1,42kg	blauw	80	80	0,35
008403030R	3	130kg	16kg	250x80	300m	1,26kg	rood	300	300	0,13
008403030S	3	130kg	16kg	250x80	300m	1,30kg	zwart	300	300	0,13
008403040S	4	220kg	27kg	250x80	200m	1,39kg	zwart	200	200	0,19
008403030W	3	130kg	16kg	250x80	300m	1,24kg	wit	300	300	0,09
008403040W	4	220kg	27kg	250x80	200m	1,39kg	wit	200	200	0,16
008403060W	6	480kg	60kg	250x80	80m	1,42kg	wit	80	80	0,35
008403080W	8	720kg	90kg	250x80	50m	1,53kg	wit	50	50	0,57
008403060RBL	6	480kg	60kg	250x80	80m	1,78kg	rood/blauw	80	80	0,35
008403080GER	8	720kg	90kg	250x80	50m	1,50kg	rood/geel	50	50	0,57



Touw 3 aderig gedraaid polypropyleen

Code 29

Art. Nr.	C	Breekpunt	Belastbaar	Spoel maat	lengte	gewicht	kleur	VE	MBH	Prijs €
008407060BL	6	560kg	70kg	250x80	70m	1,60kg	blauw	70	70	0,38
008407080BL	8	1040kg	130kg	250x180	100m	2,90kg	blauw	100	100	0,47
008407080O	8	1040kg	130kg	250x180	100m	2,90kg	oranje	100	100	0,54



TOUWEN/KETTINGEN/ACCESSOIRES

Touw spiraalgevlochten polypropyleen

Code 29



Art. Nr.	C	Breekpunt	Belastbaar	Spoel maat	lengte	gewicht	kleur	VE	MBH	Prijs €
008408080BL	6	671kg	83kg	250x180	110m	3,20kg	blauw	110	110	0,63
008408100BL	10	1070kg	133kg	250x180	60m	2,16kg	blauw	60	60	0,88
008408120BL	12	1400kg	175kg	250x180	50m	2,78kg	blauw	50	50	1,07
008408140BL	14	1770kg	221kg	250x180	40m	2,84kg	blauw	40	40	1,45

Elastisch rubber touw kleurrijk

Code 29



Kleur voorbeelden

Art. Nr.	C	Breekpunt	Belastbaar	Spoel maat	lengte	gewicht	kleur	VE	MBH	Prijs €
008412060BT	6	135%	-	250x80	80m	2,10kg	kleurrijk	80	80	0,82
008412080BT	8	175%	-	250x80	50m	1,90kg	kleurrijk	50	50	1,13
008412100BT	10	155%	-	250x80	30m	1,81kg	kleurrijk	30	30	1,83

Spanhaak voor rubber touw

Code 29



Art. Nr.	Touwdikte	Aantal	VE	MBH	Prijs €
008008060S	6 mm	2	5	5	3,75
008008080S	8 mm	2	5	5	5,60

Touw 16 strengts rondgevlochten polypropyleen

Code 29



Art. Nr.	C	Breekpunt	Belastbaar	Spoel maat	lengte	gewicht	kleur	VE	MBH	Prijs €
008414080GN	8	700kg	87kg	250x80	40m	1,35kg	groen/geel	40	40	0,66

Touw 3 strengts gevlochten polypropyleen

Code 29

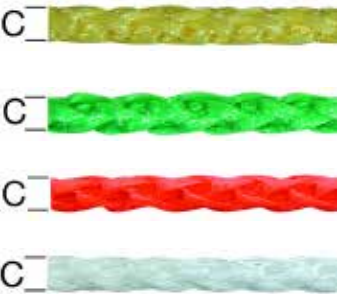

Art. Nr.	C	Breekpunt	Belastbaar	Spoel maat	lengte	gewicht	kleur	VE	MBH	Prijs €
008415040GE	4	98kg	13kg	250x80	150m	0,85kg	geel	150	150	0,16
008415040GN	4	98kg	13kg	250x80	150m	0,85kg	groen	150	150	0,16
008415040R	4	98kg	13kg	250x80	150m	0,85kg	rood	150	150	0,16
008415040W	4	98kg	13kg	250x80	150m	0,85kg	wit	150	150	0,16

Startkoord polyamide wit

Code 29



Art. Nr.	C	Breekpunt	Belastbaar	Spoel maat	lengte	gewicht	kleur	VE	MBH	Prijs €
008451035W	3,5	280kg	35kg	250x80	220m	2,37kg	wit	220	220	0,32
008451040W	4	310kg	38kg	250x80	160m	1,75kg	wit	160	160	0,32
008451050W	5	450kg	563kg	250x80	95m	1,77kg	wit	95	95	0,47

Touw gevlochten polyamide wit

Code 29



Art. Nr.	C	Breekpunt	Belastbaar	Spoel maat	lengte	gewicht	kleur	VE	MBH	Prijs €
008452016W	1,6	30kg	4kg	250x80	500m	1,34kg	wit	500	500	0,06
008452021W	2,1	55kg	8kg	250x80	500m	1,87kg	wit	500	500	0,09
008452023W	2,3	80kg	10kg	250x80	500m	1,70kg	wit	500	500	0,13
008452030W	3,0	140kg	18kg	250x80	500m	1,95kg	wit	350	350	0,19
008452036W	3,6	180kg	24kg	250x80	500m	1,92kg	wit	250	250	0,22
008452040W	4,0	240kg	30kg	250x80	500m	2,00kg	wit	200	200	0,25

TOUWEN/KETTINGEN/ACCESSOIRES

Kernmanteltouw polypropyleen wit / geel

Code 29

Art. Nr.	C	Breekpunt	Belastbaar	Spoel maat	lengte	gewicht	kleur	VE	MBH	Prijs €
008405030WGE	3	150kg	19kg	250x80	250m	1,20kg	wit/geel	250	250	0,09



Kernmanteltouw polypropyleen blauw / kleurrijk

Code 29

Art. Nr.	C	Breekpunt	Belastbaar	Spoel maat	lengte	gewicht	kleur	VE	MBH	Prijs €
008405040BLBT	4	300kg	38kg-	250x80	120m	1,20kg	blauw/ kleurrijk	120	120	0,19
008405060BLBT	6	520kg	65kg	250x80	70m	1,50kg	blauw/ kleurrijk	70	70	0,38



Kernmanteltouw polypropyleen wit / blauw

Code 29

Art. Nr.	C	Breekpunt	Belastbaar	Spoel maat	lengte	gewicht	kleur	VE	MBH	Prijs €
008405030WGE	4	300kg	38kg-	250x80	120m	1,20kg	wit/blauw	120	120	0,19



Kernmanteltouw polypropyleen geel / kleurrijk

Code 29

Art. Nr.	C	Breekpunt	Belastbaar	Spoel maat	lengte	gewicht	kleur	VE	MBH	Prijs €
008405050GEBT	5	360kg	45kg-	250x80	80m	1,20kg	geel/kleur- rijk	80	80	0,28



Kernmanteltouw polypropyleen groen / kleurrijk

Code 29

Art. Nr.	C	Breekpunt	Belastbaar	Spoel maat	lengte	gewicht	kleur	VE	MBH	Prijs €
008405060GNBT	6	520kg	65kg	250x80	70m	1,50kg	groen/ kleurrijk	70	70	0,38



Kernmanteltouw polypropyleen paars / kleurrijk

Code 29

Art. Nr.	C	Breekpunt	Belastbaar	Spoel maat	lengte	gewicht	kleur	VE	MBH	Prijs €
008405070LIBT	7	880kg	110kg	250x80	50m	1,95kg	paars/ kleurrijk	50	50	0,95



Kernmanteltouw 16 strengs gevlochten sterk polyester wit

Code 29

Art. Nr.	C	Breekpunt	Belastbaar	Spoel maat	lengte	gewicht	kleur	VE	MBH	Prijs €
008481090WS	9	2000kg	250kg	250x180	90m	5,63kg	wit	90	90	1,23
008481100WS	10	2500kg	312kg	250x180	70m	5,55kg	wit	70	70	1,51



Luiktouw polyester wit

Code 29

Art. Nr.	C	Breekpunt	Belastbaar	Spoel maat	lengte	gewicht	kleur	VE	MBH	Prijs €
008482017W	1,7	50kg	6kg	250x80	500m	1,15kg	wit	500	500	0,06
008482028W	2,8	150kg	19kg	250x80	400m	2,12kg	wit	400	400	0,13



Lijn rondgevlochten polyester wit

Code 29

Art. Nr.	C	Breekpunt	Belastbaar	Spoel maat	lengte	gewicht	kleur	VE	MBH	Prijs €
008483060W	6	600kg	75kg	250x80	85m	2,31kg	wit	85	85	0,38



TOUWEN/KETTINGEN/ACCESSOIRES

Touw gevlochten katoen

Code 29

Art. Nr.	C	Breekpunt	Belastbaar	Spoel maat	lengte	gewicht	kleur	VE	MBH	Prijs €
008490060BW	6	120kg	15kg	250x80	80m	1,27kg	Katoen	80	80	0,79

Touw gedraaid Sisal

Code 29

Art. Nr.	C	Breekpunt	Belastbaar	Spoel maat	lengte	gewicht	kleur	VE	MBH	Prijs €
008491060SL	6	255kg	30kg	250x80	60m	1,55kg	Sisal	60	60	0,79
008491080SL	8	473kg	60kg	250x180	100m	4,09kg	Sisal	100	100	1,01

Touw gedraaid Jute

Code 29

Art. Nr.	C	Breekpunt	Belastbaar	Spoel maat	lengte	gewicht	kleur	VE	MBH	Prijs €
008492080HF	8	440kg	73kg	250x80	40m	2,31kg	Jute	40	40	1,10
008492100HF	10	620kg	103kg	250x180	70m	4,42kg	Jute	70	70	1,04
008492140HF	14	1650kg	275kg	250x180	40m	4,20kg	Jute	40	40	2,52

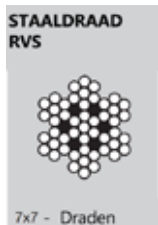

Staaldraad RVS (V4A)

Code 29

Art. Nr.	C	Breekpunt	Belastbaar	Spoel maat	lengte	gewicht	kleur	VE	MBH	Prijs €
008501010RF	1,0	61kg	8kg	250x80	500m	2,71kg	RVS V4A	500	500	0,32
008501020RF	2,0	234kg	29kg	250x80	250m	4,62kg	RVS V4A	250	250	0,72
008501030RF	3,0	530kg	66kg	250x80	150m	6,19kg	RVS V4A	150	150	1,42
008501040RF	4,0	856kg	107kg	250x80	100m	6,90kg	RVS V4A	100	100	2,14

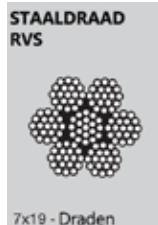

Staaldraad RVS (V4A)

Code 29

Art. Nr.	C	Breekpunt	Belastbaar	Spoel maat	lengte	gewicht	kleur	VE	MBH	Prijs €
008507050RF	5,0	1325kg	165kg	250x80	70m	7,26g	RVS V4A	70	70	3,65
008507060RF	6,0	1906kg	238kg	250x80	55m	8,04kg	RVS V4A	55	55	5,42

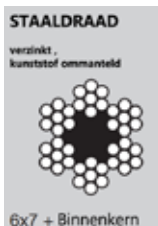

Staaldraadtouw verzinkt staalvezel Kunststof ommanteld

Code 29

Art. Nr.	C	Breekpunt	Belastbaar	Spoel maat	lengte	gewicht	kleur	VE	MBH	Prijs €
008502030ZKS	2/3	238kg	30kg	250x80	200m	2,71kg	Grijs	200	200	0,44
008502040ZKS	3/4	538kg	67kg	250x80	100m	4,62kg	Grijs	100	100	0,69
008502050ZKS	4/5	958kg	119kg	250x80	80m	6,19kg	Grijs	80	80	1,42
008502060ZKS	4/6	941kg	117kg	250x80	55m	6,90kg	Grijs	55	55	1,76



Staaldraadtouw verzinkt staalvezel

Code 29

Art. Nr.	C	Breekpunt	Belastbaar	Spoel maat	lengte	gewicht	kleur	VE	MBH	Prijs €
008500020Z	2	238kg	30kg	250x80	200m	3,16kg	Grijs	200	200	0,32
008500030Z	3	538kg	67kg	250x80	150m	4,69kg	Grijs	150	150	0,50
008500040Z	4	958kg	119kg	250x80	100m	5,85kg	Grijs	100	100	1,17
008500050Z	5	1500g	187kg	250x80	70m	6,09kg	Grijs	70	70	1,73

TOUWEN/KETTINGEN/ACCESSOIRES

Rolluik band beige polypropyleen

Code 29

Art. Nr.	Afmeting	Scheursterkte	Max gewicht	Spoel maat	Kleur	VE	MBH	Prijs €
008583150BE	15 mm	150kg	18kg	250x80	beige	50	50	0,54
008583200BE	20 mm	250kg	31kg	250x80	beige	50	50	0,82



Bandriemen polypropyleen Kleurrijk 25mm

Code 29

Art. Nr.	Afmeting	Scheursterkte	Max gewicht	Spoel maat	Kleur	VE	MBH	Prijs €
008580250BT	25 mm	500kg	62kg	250x80	kleurrijk	40	40	0,85



Bandriemen polypropyleen zwart 25mm

Code 29

Art. Nr.	Afmeting	Scheursterkte	Max gewicht	Spoel maat	Kleur	VE	MBH	Prijs €
008580250S	25 mm	220kg	27kg	250x80	zwart	50	50	0,69



Bandriemen polypropyleen olijfgroen 30mm

Code 29

Art. Nr.	Afmeting	Scheursterkte	Max gewicht	Spoel maat	Kleur	VE	MBH	Prijs €
008580300OL	30 mm	260kg	32kg	250x80	olijfgroen	30	30	0,88



Bandriemen polypropyleen kleurrijk 40mm

Code 29

Art. Nr.	Afmeting	Scheursterkte	Max gewicht	Spoel maat	Kleur	VE	MBH	Prijs €
008580400BT	40 mm	360kg	45kg	250x80	kleurrijk	30	30	1,17



Bandriemen polypropyleen blauw 50mm

Code 29

Art. Nr.	Afmeting	Scheursterkte	Max gewicht	Spoel maat	Kleur	VE	MBH	Prijs €
008580500BL	50 mm	570kg	71kg	250x80	blauw	20	20	1,26



Sleeband polypropyleen blauw

Code 29

Art. Nr.	Afmeting	Scheursterkte	Max gewicht	Spoel maat	Kleur	VE	MBH	Prijs €
008582500BL	50 mm	290kg	36kg	250x80	blauw	50	50	1,17



Klittenband zelfklevend Haken/Pluche

Code 29

Art. Nr.	Afmeting	Scheursterkte	Max gewicht	Spoel maat	Uitvoering	VE	MBH	Prijs €
008584200W	20 mm	-	-	250x80	Haken wit	40	40	1,80
008585200W	20 mm	-	-	250x80	Pluche wit	40	40	1,80



Klittenband innaaibaar Haken/Pluche zwart

Code 29

Art. Nr.	Afmeting	Scheursterkte	Max gew.	Spoel maat	Uitvoering	VE	MBH	Prijs €
008586200S	20 mm			250x80	Haken zwart	50	50	1,01
008587200S	20 mm			250x80	Pluche zwart	50	50	1,01



Klittenband innaaibaar Haken/Pluche wit

Code 29

Art. Nr.	Afmeting	Scheursterkte	Max gew.	Spoel maat	Uitvoering	VE	MBH	Prijs €
008588200W	20 mm			250x80	Haken wit	50	50	1,01
008589200W	20 mm			250x80	Pluche wit	50	50	1,01



PRODUCTEN OP MAAT

VORMANN BIJDT U OOK DE MOGELIJKHEID PRODUCTEN SPECIAAL VOOR U OP MAAT TE MAKEN.

**STUUR ONS UW AANVRAAG MET:
 HOEVEELHEDEN EN TEKENINGEN DAN MAKEN WIJ VOOR U EEN AANBIEDING.**

