



Heilenbecker Straße 191-205,
58256 Ennepetal
Hauptverwaltung



Weichselstraße 9-11, 58256 Ennepetal
Logistikzentrum



Berliner Straße 50, 04910 Elsterwerda
Werk Elsterwerda



George/Südafrika
Vertriebsniederlassung Südafrika



VORMANN beschäftigt an seinen 3 deutschen Standorten etwa 190 Mitarbeiter. Das in der 5. Generation inhabergeführte Familienunternehmen bietet neben der Produktion und dem Vertrieb von Standardsortimenten im Bereich Verbindungselemente auch die Konzeption und Herstellung von Sonderanfertigungen an. VORMANN setzt bei der Produktion auf das Gütesiegel „Made in Germany“. Mit dem Erwerb der CE-Kennzeichnung für seine statisch relevanten Holzverbinder und Stützenschuhe bietet VORMANN mehr Transparenz im Hinblick auf Produktsicherheit und -qualität. Das schon vor Jahren eingeführte Qualitätsmanagement nach DIN EN ISO 9001:2015 mit regelmäßigen Auditierungen und Überprüfungen sorgt für gleichbleibende Qualität. Mit Gründung einer eigenen Vertriebsgesellschaft in George/Südafrika zur Jahrtausendwende gelingt VORMANN der Eintritt in einen neuen Markt.



VORMANN employs roughly 190 associates at its 3 German facilities. The family-owned company, now managed by its owners in the 5th generation offers not only the production and sale of standard ranges in the area of fasteners but also the conception and production of custom-made products. In manufacturing VORMANN relies on the „Made in Germany“ quality seal. With the acquisition of the CE marking for its statically relevant timber connectors and supporting shoes, VORMANN offers more transparency with regard to product safety and quality. The quality management system according to DIN EN ISO 9001: 2015 with regular audits and inspections provides consistent quality. With the establishment of its own sales subsidiary in George/South Africa at the turn of the millennium, VORMANN successfully takes the first step into a previously little-known market.



VORMANN emploie quelque 190 personnes réparties sur un total de trois sites allemands. Parallèlement à la production et à la distribution de produits standard dans le domaine des éléments de fixation l'entreprise familiale dirigée par ses propriétaires depuis cinq générations conçoit et fabrique également sur plan des produits sur mesure. Les produits VORMANN répondent au label de qualité « Made in Germany ». L'obtention du marquage CE pour ses raccords pour constructions en bois et ses supports d'ancrage aux propriétés statiques permet par ailleurs à VORMANN d'offrir une plus grande transparence concernant la qualité et la sécurité des produits. Nos processus de gestion de la qualité conformes à la norme DIN EN ISO 9001:2015, qui sont mis en œuvre depuis déjà de nombreuses années et incluent des audits et contrôles réguliers et garantissent une qualité constante. Avec la fondation de sa propre agence commerciale à George/Afrique du Sud au tournant du millénaire, VORMANN fait ainsi ses premiers pas sur un marché jusque-là peu connu.



VORMANN cuenta en sus 3 emplazamientos alemanas por unos 190 empleados. Esta empresa familiar, que ya se encuentra en su quinta generación ofrece además de la producción y venta de productos estándar en el área de los elementos de unión la concepción y fabricación de producciones especiales. VORMANN apuesta en su producción por el sello de calidad „Made in Germany“. Con la adquisición de el distintivo CE para sus uniones para madera y apoyos de importancia estática, VORMANN ofrecer más transparencia tanto lo que respecta a la seguridad y calidad de sus productos. El sistema de gestión de calidad introducido ya hace años conforme a la norma DIN EN ISO 9001:2015, con auditorías y controles periódicos, garantiza una calidad constante. Con el establecimiento de su propia filial de ventas en George/Sudáfrica a comienzos del milenio, VORMANN consigue con éxito adentrarse en un mercado hasta entonces poco conocido.



Ausführungen

| | |
|--|------------------------|
| BR | brüniert |
| K | schwarz |
| U | ungebohrt |
| V | vermessingt |
| W | weiß |
| WA | aluweiß |
| Z | verzinkt |
| ZF | feuerverzinkt |
|  | Edelstahl Rostfrei V2A |



Surfaces

| | |
|---|---------------------|
| BR | gunmetal-finished |
| K | black |
| U | undrilled |
| V | brass-plated |
| W | white |
| WA | aluwhite |
| Z | galvanized |
| ZF | hot galvanized |
|  | stainless steel V2A |



Exécutions

| | |
|---|----------------------|
| BR | bruni |
| K | noir |
| U | non alesé |
| V | laitonné |
| W | blanc |
| WA | aluminium blanc |
| Z | galvanisé |
| ZF | galvanisé a chaud |
|  | acier inoxydable V2A |



Ejecución

| | |
|---|----------------------|
| BR | bruñido |
| K | negro |
| U | sin taladrar |
| V | latonado |
| W | blanco |
| WA | aluminio blanco |
| Z | galvanizado |
| ZF | galvanizado al fuego |
|  | acero inoxidable V2A |

Technische Angaben

| Artikel-Nr. | Ausführung | GTIN 4003984 | Abmessungen mm | | | ca. kg je VE | Schrauben | | verp. zu... Stck. |
|-------------|------------|--------------|----------------|---|--------|--------------|-----------|------|-------------------|
| | | | A | B | Stärke | | Stck. | Ø mm | |

Technical terms

| Item number | Execution | GTIN 4003984 | Dimensions mm | | | approx. kgs p. pu | screws | | Packed as... pcs. |
|-------------|-----------|--------------|---------------|---|------------|-------------------|--------|------|-------------------|
| | | | A | B | thick-ness | | pcs. | Ø mm | |

termes techniques

| Code Article | Exécutions | GTIN 4003984 | Dimensions mm | | | env. kg p. paq. | viss | | emballage à ... pcs. |
|--------------|------------|--------------|---------------|---|------------|-----------------|------|------|----------------------|
| | | | A | B | épais-seur | | psc. | Ø mm | |

Términos técnicos

| Número de artículo | Ejecución | GTIN 4003984 | Dimensiones mm | | | approx. kgs p. paq. | viss | | em-balado a... pzs. |
|--------------------|-----------|--------------|----------------|---|----------|---------------------|----------|------|---------------------|
| | | | A | B | Espe-sor | | Espe-sor | Ø mm | |



Ausführung

| |
|------------------------------|
| 1/2 Stein |
| Dornstärke |
| Abstand |
| auf Platte |
| gebogen |
| gekröpft |
| gerade |
| halbschwer |
| leicht |
| mit Anschlag |
| mit Doppelhaken |
| mit Klinkhaken |
| mit Ösen |
| mit vernietetem Messingstift |
| ohne Ösenplatten |
| schwer |
| extra schwer |
| stark / extra stark |
| zum Anschweißen |
| zum Aufschrauben |
| zum Eingipsen |
| zum Einmauern |
| zum Einschrauben |



Execution

| |
|------------------------|
| 1/2 stone |
| spindle strenght |
| distance |
| on plate |
| curved |
| cranked |
| straight |
| light heavyweight |
| light |
| with stop |
| with double hook |
| with latch hook |
| with eyelets |
| with riveted brass pin |
| without eyelet plates |
| heavy |
| extra heavy |
| strong / extra strong |
| to weld on |
| to screw on |
| to plaster in |
| to brick in |
| to screw in |



Exécutions

| |
|-----------------------------------|
| 1/2 pierre |
| Taille du boulon |
| distance |
| sur plaque |
| coubé |
| coudé |
| droit |
| semi-massifs |
| léger |
| avec butée |
| avec crochet double |
| avec crochet à cliquet |
| avec oeillets |
| avec goupille rivée en laiton |
| sans plaque de montage à oeillets |
| massif |
| hyper massif |
| fort / extra fort |
| à souder |
| à boulonner |
| à sceller au plâtre |
| à sceller |
| pour vissage |



Ejecución

| |
|--------------------------------|
| 1/2 piedra |
| espesor de la spiga |
| distancia |
| sobre placa |
| curvado |
| acodado |
| recto |
| semipesado |
| ligero |
| con tope |
| con gancho doble |
| con gancho de trinquete |
| con ojetas |
| con pasador de latón remachado |
| sin ojetas |
| pesado |
| extra pesado |
| fuerte / extra fuerte |
| para soldar |
| para atornillar |
| para enyesar |
| para empotrar |
| para encrascar |

Technische und geschmackliche Änderungen vorbehalten.

We reserve the right to make alterations of a technical nature and concerning appearance.

Sous réserve de modifications techniques et concernant l'apparence.

Salvo modificaciones técnicas y estéticas.

Bei unseren Produktbildern in diesem Katalog handelt es sich um Abbildungsbeispiele. Die unterschiedlichen Abmessungen können von ihrer Beschaffenheit (Lochanzahl und -art, Oberfläche etc.) von den gezeigten Abbildungen abweichen!

The pictures of our articles in this catalogue are only samples. The different dimensions may differ in their character (quantity and type of holes, surface etc.) from the shown pictures.

Les images de nos articles dans ce catalogue ne sont que des échantillons. Les différentes dimensions peuvent varier selon certains critères (nombre et type de perçages, finition, etc.)

Las imágenes de nuestros productos, mostradas en este catálogo, son meramente ilustrativas. Los productos pueden diferir en sus dimensiones (cantidad, tipo de agujeros, superficie, etc.) respecto a las imágenes mostradas.

| Artikel-Nr. Item number Code Article Número de artículo | Seite page page pagina | Artikel-Nr. Item number Code Article Número de artículo | Seite page page pagina | Artikel-Nr. Item number Code Article Número de artículo | Seite page page pagina |
|--|---------------------------------|--|---------------------------------|--|---------------------------------|
| 00008-00009 | 38 | 001207 | 38 | 092248 | 26 |
| 000021 | 21 | 001208 | 38 | 092264 | 37 |
| 000025 | 22 | 001209 | 37 | 092265 | 37 |
| 000028 | 39 | 001210 | 38 | | |
| 000042, 000044 | 39 | 001328 | 42 | | |
| 000062, 000064 | 11 | 010008-010009 | 38 | | |
| 000065 | 15, 18 | 010021 | 21 | | |
| 000066-000067 | 13, 15, 16, 17 | 010028 | 39 | | |
| 000068 | 15 | 010043 | 40 | | |
| 000069-000070 | 13 | 010046 | 40 | | |
| 000071-000072 | 12 | 010066-010067 | 15 | | |
| 000073 | 12, 16, 17 | 010072-010073 | 12 | | |
| 000074 | 12 | 010075 | 24 | | |
| 000075-000076 | 24 | 010082 | 25 | | |
| 000080-000081 | 22 | 010084 | 26 | | |
| 000082-000083 | 25 | 010085 | 26 | | |
| 000085-000086 | 26 | 010088 | 27 | | |
| 000088, 000090 | 27 | 010090 | 22 | | |
| 000091-000094 | 21 | 010092 | 21 | | |
| 000095 | 27 | 010096 | 39 | | |
| 000097 | 25 | 010102 | 31 | | |
| 000098 | 14 | 010104 | 30 | | |
| 000099 | 14 | 010105 | 32 | | |
| 000100 | 28 | 010124 | 11 | | |
| 000101 | 29 | 010190 | 42 | | |
| 000102-000103 | 31 | 010193 | 41 | | |
| 000104 | 30 | 010222 | 30 | | |
| 000105 | 32, 34 | 010227 | 30 | | |
| 000106 | 32 | 010240 | 41 | | |
| 000107 | 32 | 011202 | 37 | | |
| 000108-000109 | 33 | 011203 | 37 | | |
| 000110 | 33 | 011209 | 37 | | |
| 000111 | 33 | 011328 | 42 | | |
| 000112 | 19 | 011330 | 41 | | |
| 000113-000115 | 19 | 075001 | 18 | | |
| 000116, 000119 | 18 | 075045 | 18 | | |
| 000124, 000126 | 11 | 075072 | 12 | | |
| 000169-000170 | 34 | 075073 | 12 | | |
| 000190, 000192 | 42 | 090480 | 26 | | |
| 000193 | 41 | 090835 | 23 | | |
| 000197-000198 | 42 | 090837 | 23 | | |
| 000201, 000204 | 35 | 090839 | 24 | | |
| 000214-000216 | 29 | 090841 | 23 | | |
| 000217 | 39 | 091088 | 35 | | |
| 000224, 000225 | 30 | 091089 | 35 | | |
| 000226 | 29 | 091091 | 35 | | |
| 000227 | 30 | 091103 | 35 | | |
| 000239 | 34 | 091104 | 35 | | |
| 000240-000241 | 41 | 091105 | 35 | | |
| 000243 | 24 | 091946 | 31 | | |
| 000292 | 25 | 091948 | 29 | | |
| 001120 | 28 | 091964 | 37 | | |
| 001202 | 37 | 091977 | 22 | | |
| 001203 | 37 | 092198 | 31 | | |
| 001205 | 38 | 092235 | 28 | | |
| 001206 | 37 | 092236 | 26 | | |



Inhaltsverzeichnis

List of contents
Table des matières
Terminos técnicos



| Seite page page pagina | | | Seite page page pagina |
|---------------------------------|---|-------------------------------------|---------------------------------|
| 11-19 | Gehänge / Kloben / Ladenbänder / Feststeller | Gruppe 2.1 | 11-19 |
| 21-35 | Überfallen / Torbeschläge / Riegel | Gruppe 2.2 | 21-35 |
| 37-42 | Kistenbeschläge | Gruppe 2.3 | 37-42 |
| 13 | Anschweißbänder | Schatullenbeschläge | 23 |
| 25 | Barrenringe | Schlagladenüberwurf | 14 |
| 27 | Bodenschieber | Schließhaken für Spannverschlüsse | 38 |
| 29, 30, 33 | Bolzenriegel | Schlossriegel | 28, 30, 32, 33, 34 |
| 26 | Doppeltorüberwürfe | Schlösser/Zubehör | 28 |
| 40 | Edelstahl-Bänder | Sicherheitsriegel | 28, 33 |
| 41, 42 | Einlassgriffe | Sicherheits-Überfallen | 21, 22 |
| 29 | Feder-Grendelriegel | Stallriegel | 33, 34 |
| 35 | Fenster- und Türsicherungen | Spannverschlüsse | 37, 38 |
| 19 | Fensterladenbänder | Stallanwürfe | 21 |
| 14 | Fensterladenfeststeller | Sturmhaken | 25 |
| 31 | Fensterriegel | Torbeschläge | 21, 22, 26, 27, 28 |
| 18 | Flechtzaunbänder | Torfeststeller | 27 |
| 39 | Französische Kistenbänder | Türknopfriegel | 32 |
| 18 | Garagentor-Winkelbänder | Türschlossriegel | 28, 30, 32, 33, 34 |
| 26 | Gartentorfallen | Tortreibriegel | 28 |
| 26 | Gitterrostsicherung | Überfallen | 21-23 |
| 29, 30 | Grendelriegel | Universal-Kastenschloss | 28 |
| 24 | Haken mit Öse | Verstellbare Ladenbänder und Kloben | 16-17 |
| 41 | Handgriffe | Vorreiber auf Platte | 24 |
| 19 | Haustür-Mittelbänder | Werfgehänge | 11 |
| 19 | Haustür-Winkelbänder | Winkelbänder | 18, 19 |
| 11, 12, 15, 30, 41, 42 | Kataphoresse-Produkte | | |
| 39, 40 | Kistenbänder | | |
| 41 | Kistenecken | | |
| 42 | Kistengriffe | | |
| 21, 22 | Kisten-Überfallen | | |
| 27 | Klinkenbeschlag für Stalltüren | | |
| 12-13, 16-17 | Kloben | | |
| 30, 32 | Knopfriegel | | |
| 19 | Kreuzband | | |
| 11 | Kreuzgehänge | | |
| 15-17 | Ladenbänder | | |
| 25 | Manschettenhaken | | |
| 19 | Mittelbänder | | |
| 34 | Oberlichtschnäpper | | |
| 24 | Ösenplatten | | |
| 28-34 | Riegel | | |
| 34 | Riegelschlaufen | | |
| 33 | Rollenschlossriegel | | |

Seite
page
page
pagina



Seite
page
page
pagina

| Seite page page pagina | | | Seite page page pagina |
|---------------------------------|---|---|---------------------------------|
| 11-19 | Strap hinges / Pulley blocks / Shutter hinges / Stopping devices | Gruppe 2.1 | 11-19 |
| 21-35 | Padlock hasps / Gate braces / Bolts | Gruppe 2.2 | 21-35 |
| 37-42 | Chest hinges | Gruppe 2.3 | 37-42 |
| 13 | Weld-on hinges | Casket hinge | 23 |
| 25 | Pulley blocks with loop | Shutter hasp | 14 |
| 27 | Floor-fastening bolts | Locking hooks for chest locks | 38 |
| 29, 30, 33 | Bar bolts | Lock bolts | 28, 30, 32, |
| 26 | Double gate hasps | | 33, 34 |
| 40 | Stainless steel hinges | Locks/accessories | 28 |
| 41, 42 | Countersunk handles | Security bolts | 28, 33 |
| 29 | Spring grendel bolts | Security padlock latches | 21-22 |
| 35 | Window-and-door-protections | Stall door locks | 33, 34 |
| 19 | Shutter hinges | Chest locks | 37, 38 |
| 14 | Shutter stopping devices | Stall door padlock latches | 21 |
| 31 | Window bolts | Window stays | 25 |
| 18 | Wicker fence hinges | Gate fittings | 21, 22, 26, |
| 39 | French case hinges | | 27,28 |
| 18 | Garage door corner hinges | Gate stopping devices | 27,28 |
| 26 | Garden gate latches | Door bolts with knob | 32 |
| 26 | Gridiron lock | Door locking bolts | 28, 30, 32, |
| 29, 30 | Grendel bolts | | 33, 34 |
| 24 | Hooks with eyelet | Vertical gate lock | 28 |
| 41 | Handles | Padlock latches | 21-23 |
| 19 | Front door strap hinges | Universal box lock | 28 |
| 19 | Front door corner hinges | Adjustable shutter hinges and pulley blocks | 16-17 |
| 11, 12, 15, 30, | Cataphoresis articles | Casement fasteners on plate | 24 |
| 41, 42 | | Shutter hinges | 11 |
| 39, 40 | Case hinges | Corner hinges | 18, 19 |
| 41 | Chest corners | | |
| 42 | Case handles | | |
| 21, 22 | Case padlock latches | | |
| 27 | Latch brace for stable doors | | |
| 12-13, 16-17 | Pulley blocks | | |
| 30, 32 | Knop bolts | | |
| 19 | T-hinge strap | | |
| 11 | T-hinges | | |
| 15-17 | Shutter hinges | | |
| 25 | Swing clamps | | |
| 19 | Strap hinges | | |
| 34 | Skylight catches | | |
| 24 | Eyelet plates | | |
| 28-34 | Bolts | | |
| 34 | Bolt loops | | |
| 33 | Rolling shutter locking bolts | | |



Inhaltsverzeichnis

List of contents
Table des matières
Terminos técnicos



Seite
page
page
pagina

Seite
page
page
pagina

| 11-19 | Suspensiones / Gonds / Pentures volets / Arrêts | Gruppe 2.1 | 11-19 |
|---------------------------|---|-------------------------------------|---------------------------|
| 21-35 | Morillons / Ferrures de portails / Verrous | Gruppe 2.2 | 21-35 |
| 37-42 | Ferrures des coffres | Gruppe 2.3 | 37-42 |
| 13 | Pentures à souder | Charnières coffret | 23 |
| 25 | Anneaux d'écurie | Morillons pour volets à battants | 14 |
| 27 | Verouillages verticales de porte | Pattes pour fermoirs de coffre | 38 |
| 29, 30, 33 | Verrous à bouton | Boulon-verrous à serrure | 28, 30, 32, 33, 34 |
| 26 | Coulissants pour portes à deux battants | Serrures en applique/accessoires | 28 |
| 40 | Pentures en acier inoxydable | Verrous de sécurité | 28, 33 |
| 41, 42 | Poignées encastrées | Fermeoirs de sécurité pour portails | 21-22 |
| 29 | Targettes à ressort | Verrous de porte de grange | 33, 34 |
| 35 | Sécurités pour portes et fenêtres | Fermeoirs de coffre à levier | 37, 38 |
| 19 | Paumelles pour volets | Ferrures de portes de grange | 21 |
| 14 | Arrêts de volets | Crochets de contrevent | 25 |
| 31 | Targettes de fenêtre | Ferrures de portails | 21, 22, 25, 26, 27, 28 |
| 18 | Pentures étroite pour palissades | Cale-portes | 27 |
| 39 | Pentures de coffres francaises | Boulon-verrous à bouton | 32 |
| 18 | Paumelles en équerre pour portes de garage | Boulon-verrous à serrure de porte | 28, 30, 32, 33, 34 |
| 26 | Loquetes pour portillon jardin | Crémone de porte | 28 |
| 26 | Patte étroite de sécurité pour grillage | Morillons | 21-23 |
| 29, 30 | Targettes pêne rond | Serrure universelle pour coffrees | 28 |
| 24 | Crochets avec oeillet | Pentures volets et gonds réglables | 16-17 |
| 41 | Poignées | Manettes pivotantes sur plaque | 24 |
| 19 | Paumelles médianes pour port d'entrée | Pentures à charnière | 11 |
| 19 | Paumelles en équerre pour portes d'entrée | Paumelles en équerre | 18, 19 |
| 11, 12, 15, 30, 41, 42 | Articles de cataphorèse | | |
| 39, 40 | Pentures de coffre | | |
| 41 | Coins de coffre | | |
| 42 | Poignées de coffrees | | |
| 21, 22 | Morillons de coffrees | | |
| 27 | Poignée avec accessoires pour portes d'etables | | |
| 12-13, 16-17 | Gonds | | |
| 30, 32 | Boulon-verrous à bouton | | |
| 19 | Paumelle simple en T | | |
| 11 | Pentures anglaises | | |
| 15-17 | Pentures volets | | |
| 25 | Mousquetons sur bague | | |
| 19 | Paumelles médianes | | |
| 34 | Loqueteaux pour vasistas | | |
| 24 | Plaques à oeillets | | |
| 28-34 | Targettes | | |
| 34 | Pattes à gâche | | |
| 33 | Verrous de box cadennassables | | |

Seite
page
page
pagina



Seite
page
page
pagina

| Seite page page pagina | | | Seite page page pagina |
|---------------------------------|--|---|---------------------------------|
| 11-19 | Suspensiones / Goznes / Bisagras de ramal para postigos / Bloqueos | Gruppe 2.1 | 11-19 |
| 21-35 | Pestillos / Herrajes para puertas / Cerrojos | Gruppe 2.2 | 21-35 |
| 37-42 | Herrajes para cajas | Gruppe 2.3 | 37-42 |
| 13 | Bisagras para soldar | Bisagras para cofres | 23 |
| 25 | Goznes con ojete | Cierres para postigos | 14 |
| 27 | Pasadores de suelo | Ganchos de cierre de caja | 38 |
| 29, 30, 33 | Cerrojos con botón | Cerrojos para puerta con pasador | 28, 30, 32, |
| 26 | Cierres para puertas dobles | | 33, 34 |
| 40 | Bisagras de acero inoxidable | Cerradura de caja/accesories | 28 |
| 41, 42 | Asas para encajar | Cerrojos de seguridad | 28, 33 |
| 29 | Pestillos de muelle Grendel | Pestillos de seguridad para puertas | 21, 22 |
| 35 | Cerrojos de seguridad para ventanas y puertas | Pestillos para puerta de granero | 33, 34 |
| 19 | Bisagras para contraventanas | Cierres de caja | 37, 38 |
| 14 | Bloqueos para contraventanas | Cierres para puerta de granero | 21 |
| 31 | Cerrojos para ventanas | Ganchos para ventanas | 25 |
| 18 | Bisagras para cercas trenzadas | Herrajes para puertas | 21, 22, 25, |
| 39 | Bisagras francesas para cajas | | 26, 27, 28 |
| 18 | Bisagras angulares para puertas de garaje | Bloqueos de puerta | 27 |
| 26 | Cerrojos para puertas de jardines | Cerrojos de pestillo | 32 |
| 26 | Seguro para enrejados | Cerrojos para puertas | 28, 30, 32, |
| 29, 30 | Pestillos Grendel | | 33, 34 |
| 24 | Ganchos con ojete | Cierre de accionamiento de puerta | 28 |
| 41 | Empuaduras | Pestillos para puertas | 21-23 |
| 19 | Bisagras centrales para puertas de calle | Cerradura de caja universal | 28 |
| 19 | Bisagras angulares para puertas de calle | Bisagras de ramal para postigos y goznes regulables | 16-17 |
| 11, 12, 15, | Artículos de cataforesis | Aldabillas sobre placa | 24 |
| 30, 41, 42 | | Bisagras de ramal | 11 |
| 39 | Bisagras para cajas | Bisagras angulares | 18, 19 |
| 41 | Cantoneras para cajas | | |
| 42 | Asas para cajones | | |
| 21, 22 | Pestillos para cajas | | |
| 27 | Herraje para asideras para puertas de establos | | |
| 12-13, 16-17 | Goznes | | |
| 30, 32 | Cerrojos pasador con botón | | |
| 19 | Bisagra en cruz | | |
| 11 | Bisagras en cruz | | |
| 15-17 | Bisagras de ramal para postigos | | |
| 25 | Abrazaderas con gancho basculante | | |
| 19 | Bisagras centrales | | |
| 34 | Pestillos de tragaluz | | |
| 24 | Placas con ojete | | |
| 28-34 | Cerrojos | | |
| 34 | Argollas para cerrojos | | |
| 33 | Cerraderos de rodillos | | |



2.1 Gehänge / Kloben / Ladenbänder / Feststeller

Strap hinges / Pulley blocks / Shutter hinges / Stopping devices
 Suspensions / Gonds / Pentures volets / Arrêts
 Suspensiones / Goznes / Bisagras de ramal para postigos / Bloqueos

Seite
page
page
pagina



D



GB



F



E

| Seite page page pagina | | | | |
|---------------------------------|--|--|---------------------------------------|--|
| 11 | Gehänge | Strap hinges | Suspensions | Suspensiones |
| 12/13 | Kloben | Pulley-blocks | Gonds | Goznes |
| 15 | Ladenbänder | Shutter hinges | Pentures volets | Bisagras de ramal para postigos |
| 16/17 | Verstellbare Ladenbänder und Kloben | Adjustable shutter hinges and pulley blocks | Pentures volets et gonds réglables | Bisagras de ramal para postigos y goznes regulables |
| 18-19 | Mittel- und Winkelbänder | Strap hinges and corner hinges | Paumelles médianes et en équerre | Bisagras centrales y angulares |
| 19 | Fensterladenbänder | Shutter hinges | Paumelles de volets | Bisagras para contaventanas |
| 14 | Fensterladen-Feststeller | Shutter stopping devices | Arrêts de volets | Bloqueros para contaventanas |
| 18 | Flechtzaunbänder | Wicker fence hinges | Pentures étroite pour palissades | Bisagras para cercas trenzadas |

| Artikel-Nr. | Ausführung | GTIN 4003984 | Abmessungen mm | | | ca. kg je VE | Schrauben | | verp. zu... Stck. |
|-------------|---|-----------------|-------------------|----|-------------|--------------------|--------------|------------|-------------------------|
| | | | A | B | Stär- ke | | Stck. | Ø mm | |
| 000124200K | | 321570 | 200 | 33 | 2,2 | 1,64 | 2 □ 6 rd. | 8,0 5,0 | 6 |
| 000124200Z | | 320504 | 200 | 33 | 2,2 | 2,38 | 2 □ 6 rd. | 8,0 5,0 | 10 |
| 000124250K | | 321587 | 250 | 33 | 2,2 | 1,58 | 2 □ 6 rd. | 8,0 5,0 | 6 |
| 000124250Z | | 320511 | 250 | 33 | 2,2 | 2,67 | 2 □ 6 rd. | 8,0 5,0 | 10 |
| 000124300Z | | 320528 | 300 | 33 | 2,2 | 3,14 | 2 □ 7 rd. | 8,0 5,0 | 10 |
| 000124400Z | | 320535 | 400 | 33 | 2,5 | 3,99 | 2 □ 7 rd. | 8,0 5,0 | 10 |
| 010124200 |  | 180566 | 200 | 33 | 3,0 | 0,32 | 2 □ 6 rd. | 8,0 5,0 | 1 |
| 010124300 | | 180573 | 300 | 33 | 3,0 | 0,38 | 2 □ 7 rd. | 8,0 5,0 | 1 |
| | | | | 90 | 50 | | | | |

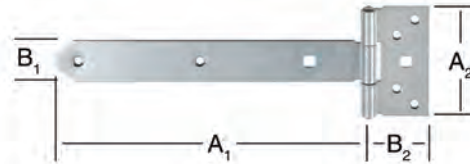

Leichte Kreuzgehänge

| | | | | | | | | | |
|------------|--|--------|-----|----|------|------|--------------|------------|----|
| 000126300Z | | 320542 | 300 | 38 | 3,5 | 5,94 | 2 □ 6 rd. | 8,0 5,0 | 10 |
| 000126400K | | 321594 | 400 | 38 | 3,5 | 4,13 | 2 □ 7 rd. | 8,0 5,0 | 6 |
| 000126400Z | | 320559 | 400 | 38 | 3,5 | 6,88 | 2 □ 7 rd. | 8,0 5,0 | 10 |
| 000126500K | | 321600 | 500 | 38 | 3,75 | 5,22 | 2 □ 8 rd. | 8,0 5,0 | 6 |
| 000126500Z | | 320566 | 500 | 38 | 3,75 | 8,47 | 2 □ 8 rd. | 8,0 5,0 | 10 |
| 000126600Z | | 320887 | 600 | 38 | 3,75 | 9,61 | 2 □ 9 rd. | 8,0 5,0 | 10 |

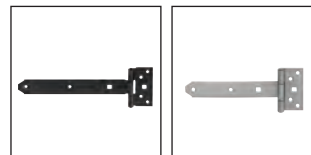

Schwere Kreuzgehänge

| | | | | | | | | | |
|------------|--|--------|-----|----|-----|------|--------------|------------|----|
| 000062200K | | 321464 | 200 | 35 | 2,5 | 1,08 | 1 □ 5 rd. | 6,0 5,0 | 6 |
| 000062200Z | | 320016 | 200 | 35 | 2,5 | 1,68 | 1 □ 5 rd. | 6,0 5,0 | 10 |
| 000062250K | | 321471 | 250 | 35 | 2,5 | 1,27 | 1 □ 5 rd. | 6,0 5,0 | 6 |
| 000062250Z | | 320023 | 250 | 35 | 2,5 | 2,15 | 1 □ 5 rd. | 6,0 5,0 | 10 |
| 000062300K | | 321488 | 300 | 35 | 2,5 | 1,55 | 1 □ 5 rd. | 8,0 5,0 | 6 |
| 000062300Z | | 320030 | 300 | 35 | 2,5 | 2,37 | 1 □ 5 rd. | 8,0 5,0 | 10 |
| 000062400Z | | 320047 | 400 | 45 | 3,0 | 5,00 | 1 □ 6 rd. | 8,0 5,0 | 10 |



Leichte Werfgehänge

| | | | | | | | | | |
|------------|--|--------|-----|----|-----|------|--------------|------------|---|
| 000064300Z | | 320054 | 300 | 45 | 4,0 | 2,11 | 2 □ 6 rd. | 8,0 5,0 | 4 |
| 000064400Z | | 320061 | 400 | 45 | 4,0 | 2,70 | 2 □ 6 rd. | 8,0 5,0 | 4 |
| 000064500Z | | 320078 | 500 | 55 | 4,0 | 3,91 | 2 □ 6 rd. | 8,0 6,0 | 4 |



Schwere Werfgehänge

„DI“-Kloben auf Platte

Dorn Ø DI
10 mm → 9,3 mm
13 mm → 11 mm
16 mm → 10 mm
20 mm → 18,2 mm

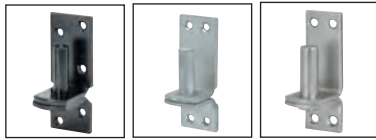
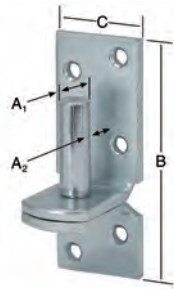

Stck./Box
2
(inkl. Schrauben)



| Artikel-Nr. | Ausführung | GTIN 4003984 | Abmessungen mm | | | ca. kg je VE | Schrauben | | verp. zu... Stck. |
|-------------|------------|-----------------|-------------------|-----|----|--------------------|-----------|------|-------------------------|
| | | | A | B | C | | Stck. | Ø mm | |
| 000073010K | | 321556 | 10/9,3 | 85 | 33 | 1,20 | 6 | 3,5 | 10 |
| 000073010Z | | 320290 | 10/9,3 | 85 | 33 | 1,18 | 6 | 4,0 | 10 |
| 000073013K | | 321563 | 13/11 | 99 | 39 | 2,78 | 6 | 5,0 | 10 |
| 000073013Z | | 320306 | 13/11 | 102 | 39 | 2,73 | 6 | 5,0 | 10 |
| 000073013ZF | | 321303 | 13/11 | 102 | 35 | 2,13 | 4 | 5,0 | 10 |
| 000073016Z | | 320313 | 16/10 | 102 | 40 | 3,02 | 6 | 5,0 | 10 |
| 000073016ZF | | 321310 | 16/10 | 126 | 40 | 3,49 | 6 | 6,5 | 10 |
| 000073020Z | | 320634 | 20/18,2 | 164 | 60 | 3,00 | 6 | 6,5 | 4 |
| 000073020ZF | | 321693 | 20/18,2 | 164 | 60 | 0,93 | 6 | 6,5 | 1 |
| 010073013 | | 180504 | 13/11 | 100 | 30 | 0,20 | 4 | 5,0 | 1 |
| 010073016 | | 180511 | 16/10 | 120 | 40 | 0,32 | 6 | 6,0 | 1 |
| 075073000 | | 321457 | 10/9,3 | 85 | 33 | 1,46 | 6 | 4,0 | 5 |

„DII“-Kloben auf Platte

Dorn Ø DII
10 mm → 26 mm
13 mm → 23 mm
16 mm → 23 mm
20 mm → 30 mm

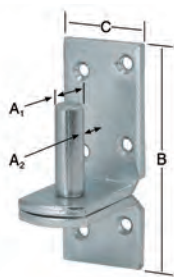

| | | | | | | | | | |
|-------------|--|--------|-------|-----|----|------|---|-----|----|
| 000074010Z | | 320320 | 10/26 | 85 | 33 | 1,35 | 6 | 3,5 | 10 |
| 000074013Z | | 320337 | 13/23 | 103 | 39 | 3,05 | 4 | 5,0 | 10 |
| 000074013ZF | | 321327 | 13/23 | 98 | 35 | 2,76 | 4 | 6,5 | 10 |
| 000074016Z | | 320344 | 16/23 | 103 | 39 | 3,37 | 6 | 5,0 | 10 |
| 000074016ZF | | 321334 | 16/23 | 120 | 40 | 3,82 | 4 | 6,5 | 10 |
| 000074020Z | | 320351 | 20/30 | 164 | 60 | 4,09 | 6 | 6,5 | 4 |
| 000074020ZF | | 321709 | 20/30 | 164 | 60 | 1,03 | 6 | 6,5 | 1 |

„J“-Kloben

zum Einschrauben
mit angeschnittenem
Gewinde

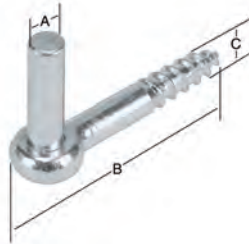

| | | | | | | | | | |
|------------|--|--------|----|-----|----|------|---|---|----|
| 000072001Z | | 321426 | 10 | 80 | 12 | 0,73 | - | - | 10 |
| 000072010Z | | 320276 | 10 | 110 | 12 | 0,90 | - | - | 10 |
| 000072013Z | | 320283 | 13 | 115 | 12 | 1,49 | - | - | 10 |
| 000072113Z | | 320580 | 13 | 160 | 12 | 3,74 | - | - | 20 |
| 000072116Z | | 320702 | 16 | 160 | 12 | 5,10 | - | - | 20 |
| 010072013 | | 180498 | 13 | 140 | 12 | 0,18 | - | - | 1 |
| 075072000 | | 321440 | 10 | 80 | 12 | 0,85 | - | - | 5 |

Gewinde- kloben

zum
Durchschrauben
mit Gewinderosette

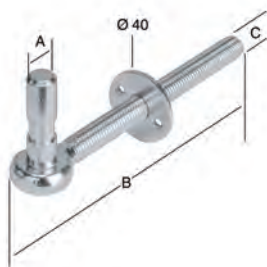

| | | | | | | | | | |
|------------|--|--------|----|-----|----|------|---|---|----|
| 000071010Z | | 320252 | 10 | 115 | 10 | 2,52 | - | - | 20 |
| 000071013Z | | 320269 | 13 | 115 | 12 | 4,42 | - | - | 20 |

„N“-Kloben

zum
Durchschrauben
mit Platte

a = 16 mm
bei Dorn-Ø 16 mm
a = 27 mm
bei Dorn-Ø 20 mm

für Schraube M16

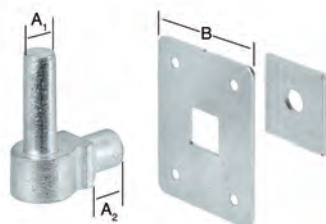

| | | | | | | | | | |
|------------|--|--------|----|----|--|------|---|---|----|
| 000071116Z | | 320665 | 16 | 64 | | 4,42 | - | - | 10 |
| 000071120Z | | 320672 | 26 | 80 | | 8,02 | - | - | 10 |

| Artikel-Nr. | Ausführung | GTIN 4003984 | Abmessungen mm | | | | ca. kg je VE | Schrauben | | verp. zu... Stck. |
|-------------|------------|-----------------|-------------------|-----|-------------------|-------------|--------------------|-----------|-----|-------------------------|
| | | | A | B | für Dorn- Ø | Stär- ke | | Stck. | Ømm | |
| 000070016Z | | 320245 | 16 | 145 | | 6,0 | 7,98 | - | - | 20 |

„G“-Kloben
zum Einmauern
1/2 Stein

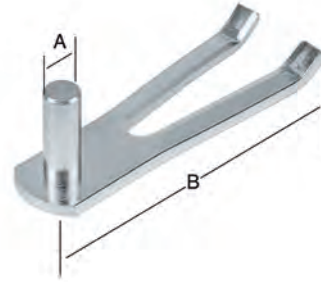

| | | | | | | | | | | |
|------------|--|--------|----|-----|--|-----|------|---|---|----|
| 000069013Z | | 320214 | 13 | 115 | | 5,0 | 4,88 | - | - | 20 |
| 000069016Z | | 320221 | 16 | 155 | | 5,0 | 7,64 | - | - | 20 |

„F“-Kloben
zum Eingipsen

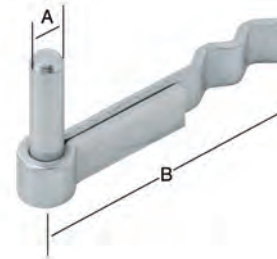

| | | | | | | | | | | |
|------------|--|--------|----|----|--|------|------|---|---|----|
| 000069013U | | 320696 | 13 | 55 | | 10,0 | 4,39 | - | - | 20 |
| 000069016U | | 320689 | 16 | 65 | | 12,0 | 6,53 | - | - | 20 |

Kloben
zum Anschweißen
Eisen blank

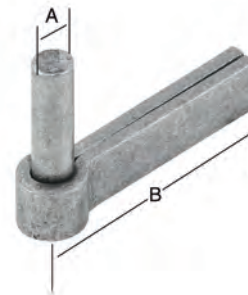

| | | | | | | | | | | |
|------------|--|--------|-----|----|----|-----|------|---|---|----|
| 000066100U | | 320719 | 100 | 40 | 13 | 5,0 | 4,42 | - | - | 20 |
| 000067100U | | 320795 | 100 | 45 | 16 | 5,0 | 5,16 | - | - | 20 |

**Anschweiß-
bänder**
für Dorn-Ø
13 – 16 mm
Eisen blank

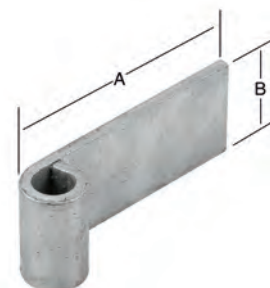

Fensterladen-Feststeller

Shutter stopping devices
Arrêts de volets
Bloqueos para contaventanas

Fensterladen-Feststeller zum Einschrauben

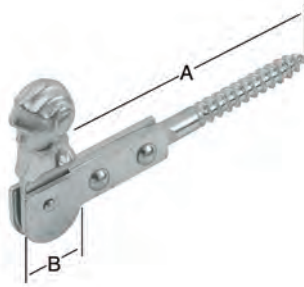

| Artikel-Nr. | Ausführung | GTIN 4003984 | Abmessungen mm | | | ca. kg je VE | Schrauben | | verp. zu... Stck. |
|-------------|------------|-----------------|-------------------|----|-------------------|--------------------|-----------|------|-------------------------|
| | | | A | B | Ø Ge- winde | | Stck. | Ø mm | |
| 000099005Z | | 320436 | 120 | 25 | 10x55 | 1,76 | - | - | 10 |
| 000099015Z | | 320467 | 165 | 25 | 10x55 | 4,01 | - | - | 20 |

Fensterladen-Feststeller zum Einschrauben mit Anschlag

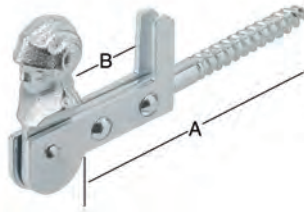

| | | | | | | | | | |
|------------|--|--------|-----|----|-------|------|---|---|----|
| 000099030Z | | 320931 | 120 | 35 | 10x55 | 3,76 | - | - | 20 |
|------------|--|--------|-----|----|-------|------|---|---|----|

Fensterladen-Feststeller zum Aufschrauben

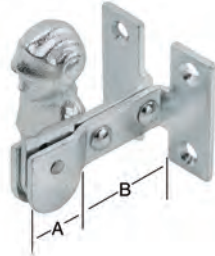

| | | | | | | | | | |
|------------|--|--------|----|----|---|------|---|-----|---|
| 000099010Z | | 320450 | 25 | 35 | - | 0,83 | 4 | 5,5 | 5 |
|------------|--|--------|----|----|---|------|---|-----|---|

Sicherheits-Schlagladen-Überwürfe mit Griffmulde

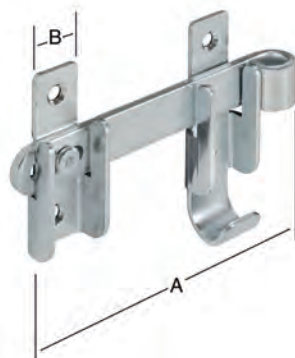

| | | | | | | | | | |
|------------|--|--------|-----|----|---------------|------|---|-----|----|
| 000098000Z | | 320412 | 120 | 18 | Stärke 3,0 | 1,53 | 4 | 4,0 | 10 |
|------------|--|--------|-----|----|---------------|------|---|-----|----|



Shutter hinges
Pentures volets
Bisagras de ramal para postigos

| Artikel-Nr. | Ausführung | GTIN 4003984 | Abmessungen mm | | | | ca. kg je VE | Schrauben | | verp. zu... Stck. |
|-------------|------------|-----------------|-------------------|----|-------------------|--------|--------------------|-----------|------|-------------------------|
| | | | A | B | für Dorn- Ø | Stärke | | Stck. | Ømm | |
| 000065300K | | 321495 | 300 | 30 | 10 | 3,5 | 1,95 | 1 □ | 9,0 | 6 |
| 000065300Z | | 320085 | 300 | 30 | 10 | 3,5 | 2,72 | 2 rd. | 6,0 | 10 |
| 000065400K | | 321501 | 400 | 30 | 10 | 3,5 | 2,49 | 1 □ | 9,0 | 6 |
| 000065400Z | | 320092 | 400 | 30 | 10 | 3,5 | 3,60 | 3 rd. | 6,0 | 10 |
| 000065500Z | | 320733 | 500 | 30 | 10 | 3,5 | 5,12 | 1 □ | 9,0 | 10 |
| | | | | | | | | 4 rd. | 6,0 | |
| 000066300K | | 321518 | 300 | 37 | 13 | 5,0 | 2,96 | 1 □ | 9,0 | 6 |
| 000066300Z | | 320108 | 300 | 37 | 13 | 5,0 | 4,58 | 2 rd. | 6,0 | 10 |
| 000066300ZF | | 321204 | 300 | 40 | 13 | 5,0 | 4,60 | 1 □ | 9,0 | 10 |
| 000066400K | | 321525 | 400 | 37 | 13 | 5,0 | 3,89 | 2 rd. | 6,0 | 6 |
| 000066400Z | | 320115 | 400 | 37 | 13 | 5,0 | 5,98 | 1 □ | 9,0 | 10 |
| 000066400ZF | | 321211 | 400 | 40 | 13 | 5,0 | 6,48 | 3 rd. | 6,0 | 10 |
| 000066500K | | 321532 | 500 | 37 | 13 | 5,0 | 5,53 | 1 □ | 9,0 | 6 |
| 000066500Z | | 320122 | 500 | 37 | 13 | 5,0 | 7,32 | 4 rd. | 6,0 | 10 |
| 000066500ZF | | 321228 | 500 | 40 | 13 | 5,0 | 8,51 | 1 □ | 9,0 | 10 |
| 000066600K | | 321549 | 600 | 37 | 13 | 5,0 | 5,50 | 3 rd. | 6,0 | 6 |
| 000066600Z | | 320139 | 600 | 37 | 13 | 5,0 | 8,80 | 1 □ | 9,0 | 10 |
| 000066600ZF | | 321235 | 600 | 40 | 13 | 5,0 | 10,49 | 4 rd. | 6,0 | 10 |
| 000066700Z | | 320740 | 700 | 37 | 13 | 5,0 | 11,52 | 1 □ | 9,0 | 10 |
| 000066800Z | | 320757 | 800 | 37 | 13 | 5,0 | 13,73 | 4 rd. | 6,0 | 10 |
| | | | | | | | | 4 rd. | 6,0 | |
| 010066400 | | 510547 | 400 | 40 | 13 | 4,0 | 0,54 | 1 □ | 9,0 | 1 |
| 010066500 | | 510554 | 500 | 40 | 13 | 4,0 | 0,65 | 2 rd. | 6,0 | 1 |
| 010066600 | | 510578 | 600 | 40 | 13 | 4,0 | 0,80 | 1 □ | 9,0 | 1 |
| | | | | | | | | 3 rd. | 6,0 | |
| 000067000Z | | 320146 | 1000 | 45 | 16 | 5,0 | 7,80 | 1 □ | 9,0 | 4 |
| 000067500Z | | 320771 | 500 | 45 | 16 | 5,0 | 10,32 | 5 rd. | 8,0 | 10 |
| 000067600Z | | 320153 | 600 | 45 | 16 | 5,0 | 11,79 | 1 □ | 9,0 | 10 |
| 000067600ZF | | 321266 | 600 | 45 | 16 | 5,0 | 6,76 | 4 rd. | 8,0 | 5 |
| 000067700Z | | 320627 | 700 | 45 | 16 | 5,0 | 11,95 | 1 □ | 11,0 | 10 |
| 000067800Z | | 320160 | 800 | 45 | 16 | 5,0 | 13,96 | 3 rd. | 8,0 | 10 |
| 000067800ZF | | 321280 | 800 | 45 | 16 | 5,0 | 9,12 | 1 □ | 9,0 | 5 |
| | | | | | | | | 5 rd. | 8,0 | |
| | | | | | | | | 4 rd. | 8,0 | |
| 010067600 | | 510585 | 600 | 45 | 16 | 5,0 | 1,14 | 1 □ | 9,0 | 1 |
| 010067800 | | 510561 | 800 | 45 | 16 | 5,0 | 1,43 | 4 rd. | 8,0 | 1 |
| | | | | | | | | 1 □ | 9,0 | |
| | | | | | | | | 5 rd. | 8,0 | |
| 000068000Z | | 320177 | 1000 | 60 | 20 | 8,0 | 7,72 | 1 □ | 9,0 | 2 |
| 000068120Z | | 320184 | 1200 | 60 | 20 | 8,0 | 9,36 | 4 rd. | 8,0 | 2 |
| 000068800Z | | 320191 | 800 | 60 | 20 | 8,0 | 13,43 | 1 □ | 11,0 | 4 |
| 000068800ZF | | 321686 | 800 | 60 | 20 | 8,0 | 2,94 | 4 rd. | 8,0 | 1 |
| | | | | | | | | 1 □ | 9,0 | |
| | | | | | | | | 3 rd. | 8,0 | |

**Leichte
Ladenbänder**
für Dorn-Ø 10 mm

**Halbschwere
Ladenbänder**
für Dorn-Ø 13 mm

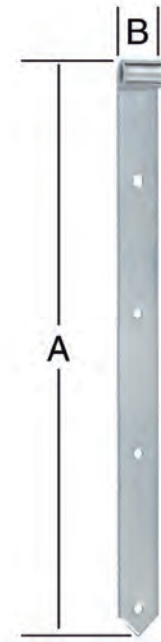

**Schwere
Ladenbänder**
für Dorn-Ø 16 mm

**Extra
schwere
Ladenbänder**
für Dorn-Ø 20 mm

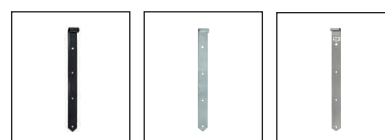

Verstellbare Ladenbänder und Kloben DBGM

Verstellbereich mittels
Verstell-Sechskantschraube
bis max. 40 mm

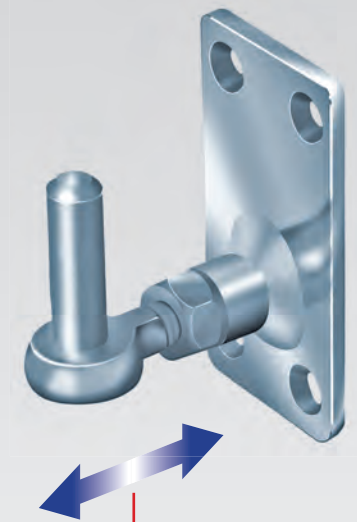
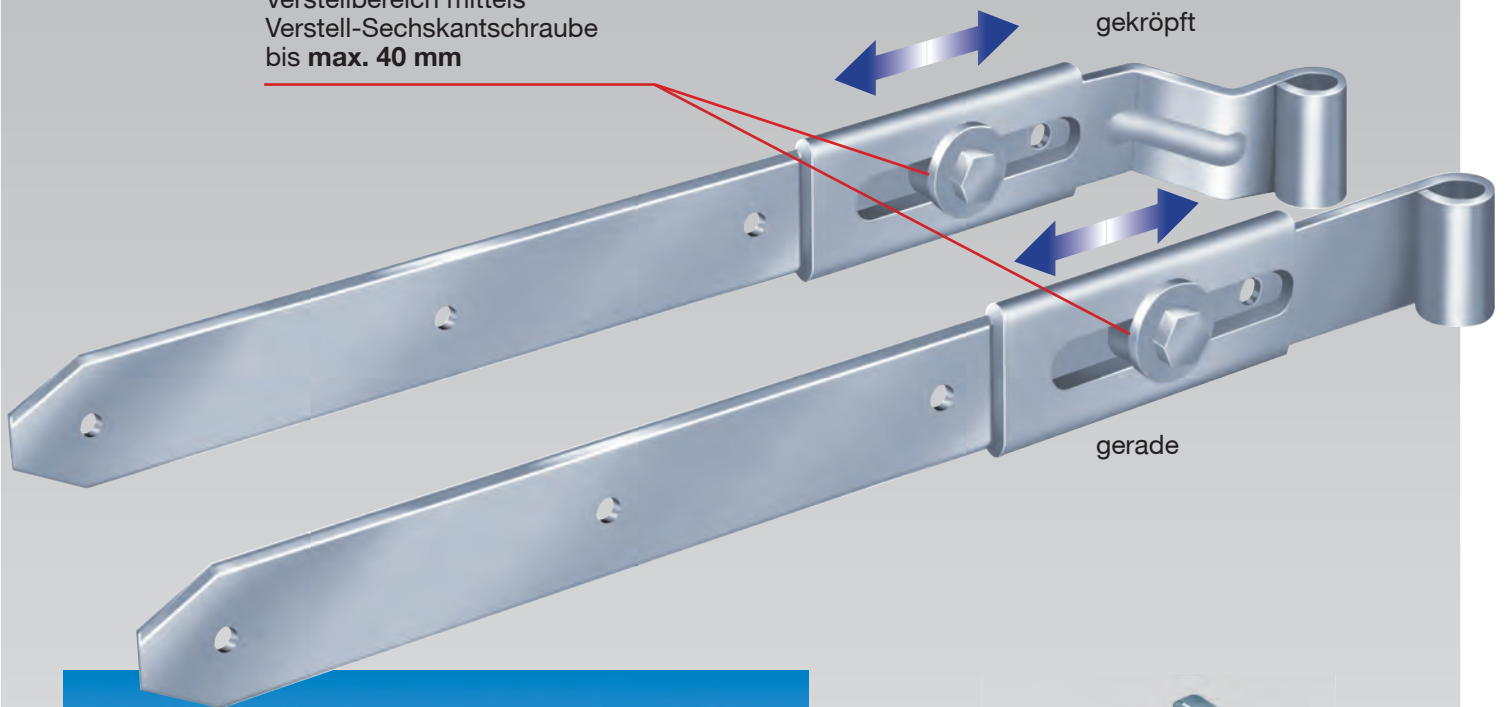

Verstellbereich
bis max. 15 mm

- Problemlose Überbrückung nicht lotrechter und unebener Wände, Pfosten und Pfeiler sowie bei Holzverwindungen
- Problemloses Nachjustieren bei verarbeitungs- und materialbedingtem Durchhängen von Toren
- Verstellmechanismus gewährleistet nach Montage unverrückbaren Sitz
- Ansprechendes Design
- Komplettdesign für leichte und schwere Tore
- Vielfältige Anwendungsvarianten (siehe Abbildung rechts unten)

| Artikel-Nr. | Ausführung | GTIN 4003984 | Abmessungen mm | | | | ca. kg je VE | Schrauben | | verp. zu... Stck. |
|-------------|------------|-----------------|-------------------|---|-------------------|-------------|--------------------|-----------|-----|-------------------------|
| | | | A | B | für Dorn- ø | Stär- ke | | Stck. | Ømm | |

| | | | | | | | | | | |
|------------|--|--------|-----|----|----|-----|------|-----|-------------|---|
| 000066501Z | | 321129 | 500 | 40 | 13 | 5,0 | 4,08 | 3/1 | 8,0/ 8,5 | 4 |
| 000066701Z | | 321150 | 700 | 40 | 13 | 5,0 | 5,28 | 4/1 | 8,0/ 8,5 | 4 |
| 000067801Z | | 321181 | 800 | 50 | 16 | 6,0 | 9,05 | 5/1 | 8,0/ 8,5 | 4 |

| | | | | | | | | | | |
|------------|--|--------|-----|----|----|-----|------|-----|-------------|---|
| 000066502Z | | 321136 | 500 | 40 | 13 | 5,0 | 4,15 | 3/1 | 8,0/ 8,5 | 4 |
| 000066702Z | | 321143 | 700 | 40 | 13 | 5,0 | 5,41 | 4/1 | 8,0/ 8,5 | 4 |
| 000067802Z | | 321198 | 800 | 50 | 16 | 6,0 | 9,28 | 5/1 | 8,0/ 8,5 | 4 |

Verstellbare Ladenbänder und Kloben

Adjustable shutter hinges and pulley blocks
 Pentures volets et gonds réglables
 Bisagras de ramal para postigos y goznes regulables

Verstellbare Ladenbänder

Verstellbereich
bis max. 40 mm

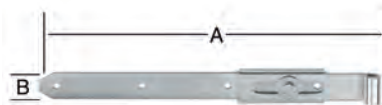

gerade Ausführung

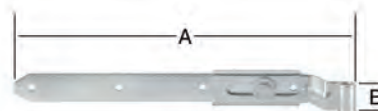

gekröpfte Ausführung

| Artikel-Nr. | Ausführung | GTIN 4003984 | Abmessungen mm | | | | ca. kg je VE | Schrauben | | verp. zu... Stck. |
|-------------|------------|-----------------|-------------------|---|---|-------------|--------------------|-----------|-----|-------------------------|
| | | | A | B | C | Stär- ke | | Stck. | Ømm | |

| | | | | | | | | | | |
|------------|--|--------|----|----|-----|-----|------|---|-----|---|
| 000073113Z | | 321105 | 13 | 50 | 100 | 5,0 | 1,48 | 4 | 6,0 | 4 |
| 000073116Z | | 321112 | 16 | 50 | 120 | 6,0 | 2,33 | 6 | 6,0 | 4 |



Verstellbare Kloben

Anwendungsvarianten für verstellbares Ladenband
in Verbindung mit verstellbaren Kloben.

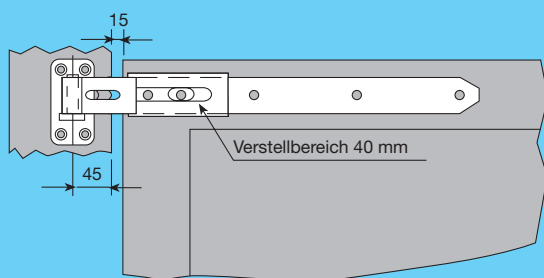

Weitere Anwendungsvarianten:
 Verstellbare Ladenbänder in Verbindung
 mit starren handelsüblichen Kloben
 oder
 verstellbare Kloben in Verbindung
 mit starren handelsüblichen Ladenbändern.

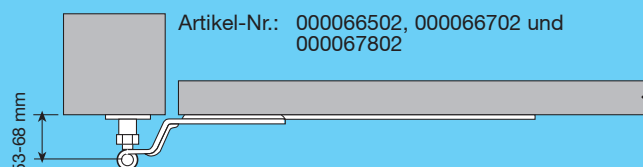
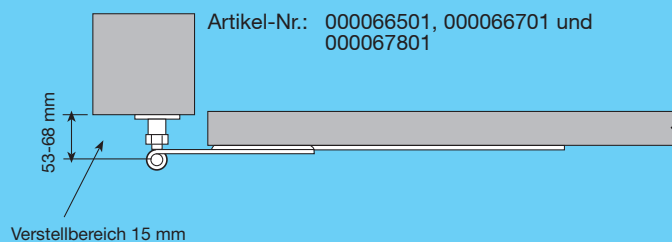

Flechtzaunbänder

Wicker fence hinges
 Pentures étroite pour palissades
 Bisagras para cercas trenzadas

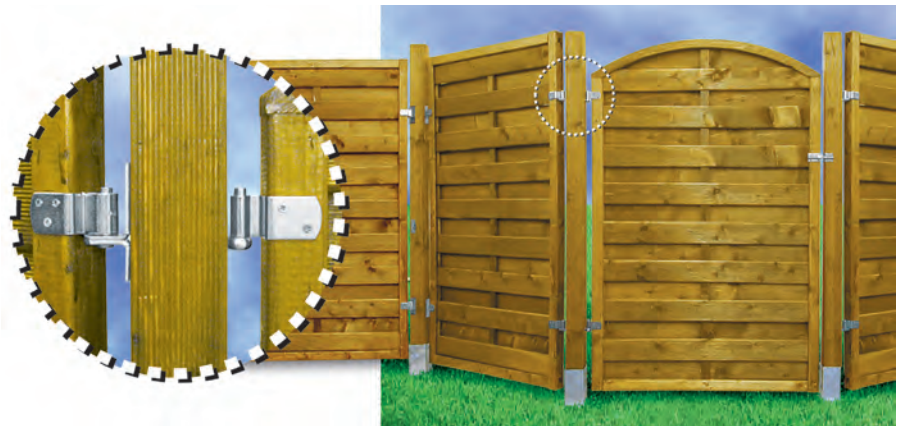

Universal Flechtzaunbänder-

Die schnelle und sichere Verbindung

Flechtzaun- bänder

L-Form
 für universelle
 Rahmenstärken
 verzinkt

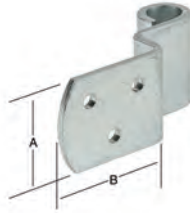

| Artikel-Nr. | GTIN 4003984 | Abmessungen mm | | | für Dorn Ø mm | ca. kg. je VE | Schrauben | | verp. zu... Stck. |
|--------------------------------|-----------------|-------------------|----|--------|---------------------|------------------|-----------|------|--|
| | | A | B | Stärke | | | Stck. | Ø mm | |
| 000065001Z | 321402 | 30 | 38 | 3,0 | 10 | 1,39 | 3 | 4,0 | 20 |
| 075001000 SB- Verpackung | 380461 | 30 | 38 | 3,0 | 10 | 0,89 | 3 | 4,0 | 5 Boxen à 2 Stck. mit Schrauben |



Flechtzaun- bänder

beidseitig schraubbar
 für 45 mm Rahmen
 verzinkt



| | | | | | | | | | |
|--------------------------------|--------|----|----|-----|----|------|---|-----|--|
| 000065045Z | 321419 | 45 | 38 | 2,0 | 10 | 0,80 | 4 | 4,0 | 10 |
| 075045000 SB- Verpackung | 380478 | 45 | 38 | 2,0 | 10 | 0,96 | 4 | 4,0 | 5 Boxen à 2 Stck. mit Schrauben |



Mittel- und Winkelbänder

Strap hinge corner hinge
 Paumelles médianes et en équerre
 Bisagras centrales y angulares

Haustür- Winkelbänder

für Dorn-Ø 16 mm

verpackt zu
 1 Stck. links
 und
 1 Stck. rechts

(Abb. rechts)

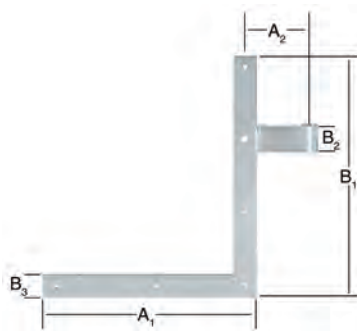

| Artikel-Nr. | Ausführung | GTIN 4003984 | Abmessungen mm | | | ca. kg je VE | Schrauben | | verp. zu... Stck. |
|-------------|------------|-----------------|-------------------|-----|--------|--------------------|-----------|------|-------------------------|
| | | | A | B | Stärke | | Stck. | Ø mm | |
| 000116350Z | | 320832 | 350 | 400 | 5,0 | 2,68 | 1 □ | 8,0 | 2 |
| | | | 105 | 45 | 6,0 | | 5 rd. | 6,0 | |
| | | | | 40 | 5,0 | | | | |
| 000116600Z | | 320498 | 600 | 400 | 5,0 | 3,46 | 1 □ | 8,0 | 2 |
| | | | 105 | 45 | 6,0 | | 7 rd. | 6,0 | |
| | | | | 45 | 6,0 | | | | |
| 000116800Z | | 320849 | 800 | 400 | 5,0 | 3,95 | 1 □ | 8,0 | 2 |
| | | | 105 | 45 | 6,0 | | 8 rd. | 6,0 | |
| | | | | 40 | 5,0 | | | | |

Garagentor- Winkelbänder

für Dorn-Ø 20 mm

verpackt zu
 1 Stck. links
 und
 1 Stck. rechts

(Abb. rechts)

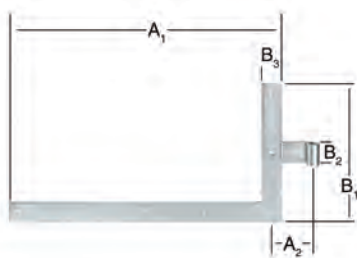

| | | | | | | | | | |
|------------|--|--------|------|-----|-----|-------|-------|------|---|
| 000119000Z | | 320870 | 1000 | 400 | 8,0 | 11,08 | 1 rd. | 10,0 | 2 |
| | | | 120 | 60 | 8,0 | | 7 rd. | 8,0 | |
| | | | | 60 | 8,0 | | | | |
| 000119800Z | | 320863 | 800 | 400 | 8,0 | 9,78 | 1 rd. | 10,0 | 2 |
| | | | 120 | 60 | 8,0 | | 6 rd. | 8,0 | |
| | | | | 60 | 8,0 | | | | |

| Artikel-Nr. | Ausführung | GTIN 4003984 | Abmessungen mm | | | ca. kg je VE | Schrauben | | verp. zu... Stck. |
|-------------|------------|-----------------|-------------------|----------|------------|--------------------|--------------|------------|-------------------------|
| | | | A | B | Stärke | | Stck. | Ø mm | |
| 000112300Z | | 320825 | 300 105 | 40 45 | 5,0 6,0 | 3,60 | 1 □ 2 rd. | 8,0 6,0 | 5 |

Fensterladenbänder



Shutter hinges
Paumelles pour volets
Bisagras para contraventanas

**Haustür-
Mittelbänder**
für Dorn-Ø 16 mm



| | | | | | | | | | |
|------------|--|--------|-----------|----------|------------|------|--------------|------------|----|
| 000113160Z | | 320474 | 160 35 | 55 75 | 2,0 4,0 | 2,92 | 8 rd. 1 □ | 5,0 8,0 | 10 |
|------------|--|--------|-----------|----------|------------|------|--------------|------------|----|

Kreuzbänder
für Dorn-Ø 13 mm

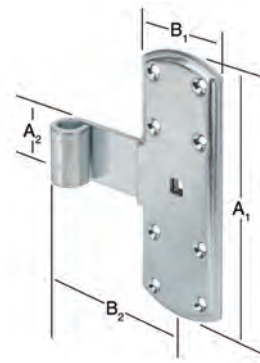

| | | | | | | | | | |
|------------|--|--------|-----------|----------|------------|------|----------------|------------|---|
| 000114200Z | | 320801 | 200 75 | 30 35 | 3,0 4,0 | 1,41 | 1 rd. 2 rd. | 8,0 5,0 | 5 |
|------------|--|--------|-----------|----------|------------|------|----------------|------------|---|

**Fensterladen-
Mittelbänder**
für Dorn-Ø 13 mm



| | | | | | | | | | |
|------------|--|--------|-----------|-----------------|-------------------|------|--------------|------------|---|
| 000115250Z | | 320481 | 200 75 | 250 35 30 | 3,0 4,0 3,0 | 0,88 | 5 rd. 1 □ | 5,0 8,0 | 2 |
| 000115350Z | | 320818 | 350 75 | 250 35 30 | 3,0 4,0 3,0 | 1,12 | 5 rd. 1 □ | 5,0 8,0 | 2 |

**Fensterladen-
Winkelbänder**
für Dorn-Ø 13 mm

verpackt zu
1 Stck. links und
1 Stck. rechts

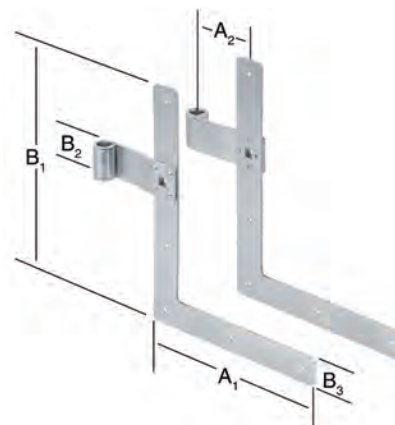



2.2 Überfallen / Torbeschläge / Riegel

Padlock latches / Gate fittings / Bolts
 Moraillons / Ferrures de portails / Targettes
 Pestillos para puertas / HERRAJES para puertas / Cerrojos

Seite
page
pagina



D



GB



F



E

| Seite page pagina | Deutsch | United Kingdom | France | Spain |
|-------------------------|---|---|---|--|
| 21 | Stallanwürfe / Überfallen | Stall door padlock latches / Padlock latches | Ferrures de portes de grange / Moraillons | Cierres para puerta de granero / Pestillos para puertas |
| 21-23 | Überfallen | Padlock latches | Moraillons | Pestillos para puertas |
| 24 | Ösenplatten / Vorreiber | Eyelet plates / Casement fasteners | Plaques à œillets / Manettes pivotantes | Placas con ojete / Aldabillas |
| 25 | Sturmhaken / Barrenringe / Manschettenhaken | Window stays / Pulley blocks with loop / Swing clamps | Crochets de contrevent / Anneaux d'écurie / Mousquetons sur bague | Ganchos para ventanas / Goznes con ojete / Abrazaderas con gancho basculante |
| 26/27 | Klinkenbeschläge / Torbeschläge | Latch brace / Gate fittings | Poignée avec accessoires / Ferrures de portails | Herraje para asideras / HERRAJES para puertas |
| 27 | Bodenschieber / Torfeststeller | Floor-fastening bolts / Gate stopping devices | Verouillages verticales de porte / Cale-portes | Pasadores de suelo / Bloqueos de puerta |
| 28-34 | Riegel und Schlaufen | Bolts and bolt loops | Targettes et pattes à gâche | Cerrojos y argollas para cerrojos |
| 34 | Oberlichtschnäpper | Skylight catches | Loqueteaux pour vasistas | Pestillos de tragaluz |
| 35 | Fenster- und Türsicherung | Window- and door-protection | Verrou de sécurité pour fenêtres et portes | Cerrojo de seguridad para ventanas y puertas |

Stallanwürfe/Überfallen



Stall door padlock latches / Padlock latches
 Ferrures de portes de grange / Moraillons
 Cierres para puerta de granero / Pestillos para puertas

| Artikel-Nr. | Ausführung | GTIN 4003984 | Abmessungen mm | | | ca. kg je VE | Schrauben | | verp. zu... Stck. |
|-------------|------------|-----------------|-------------------|----|--------|--------------------|-----------|------|-------------------------|
| | | | A | B | Stärke | | Stck. | Ø mm | |
| 000093160Z | | 320399 | 160 | 30 | 3,0 | 1,00 | 2 | 4,5 | 10 |
| 000093250Z | | 320405 | 250 | 32 | 4,0 | 2,18 | 1 | 3,5 | 10 |
| | | | | | | | 3 | 5,0 | |
| | | | | | | | 1 | 4,0 | |

Stallanwürfe

ohne Ösenplatten

passende
 Ösenplatte
 Nr. 000075035Z



| | | | | | | | | | |
|------------|--|--------|-----------|----|-----|------|--------------|------------|----|
| 000094300Z | | 320924 | 250 50 | 35 | 3,0 | 2,16 | 2 rd. 1 □ | 5,0 7,0 | 10 |
|------------|--|--------|-----------|----|-----|------|--------------|------------|----|

Überfallen

ohne Ösenplatte

passende
 Ösenplatte
 Nr. 000075035Z



| | | | | | | | | | |
|------------|--|--------|------------|----|-----|------|--------|------------|----|
| 000092250Z | | 080460 | 100 150 | 35 | 2,5 | 2,28 | 3 4 | 4,5 3,5 | 10 |
| 000092300Z | | 080477 | 80 200 | 35 | 2,5 | 2,41 | 3 | 4,5 | 10 |
| | | | | | | | 3 | 4,5 | |
| | | | | | | | 4 | 3,5 | |
| 010092200 | | 180085 | 100 100 | 35 | 2,0 | 0,81 | 2 4 | 4,5 3,5 | 5 |

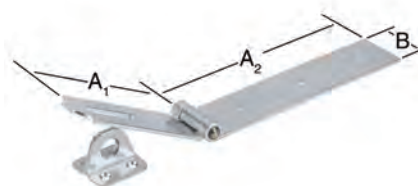

Überfallen

mit angebundener
 Ösenplatte
 (Ø 11,5 mm)



| | | | | | | | | | |
|------------|--|--------|-----------|----|-----|------|------------|----------------|----|
| 000021140Z | | 080033 | 85 30 | 35 | 2,5 | 1,22 | 8 1 □ | 4,5 6,0 | 10 |
| 000021160Z | | 080064 | 105 55 | 35 | 2,5 | 1,55 | 8 1 □ | 4,5 6,0 | 10 |
| 000021180Z | | 080071 | 125 55 | 35 | 2,5 | 1,88 | 8 1 □ | 4,5 6,0 | 10 |
| 010021145 | | 180580 | 100 45 | 35 | 2,0 | 0,65 | 4/3 1 □ | 3,5/4,5 6,0 | 5 |

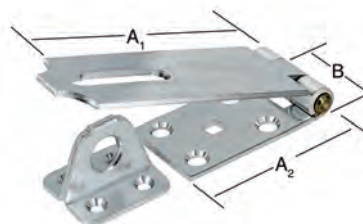

Sicherheits-Überfallen

mit angebundener
 Ösenplatte
 (Ø 11,5 mm)



Überfallen

Padlock latches
Morillons
Pestillos para puertas

Gerollte extra starke Sicherheits- Überfallen

mit angebundener
Ösenplatte
(Ø 20 mm)

mit vernietetem
Messingstift

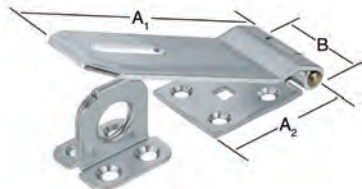

Sicherheits- Überfallen

mit angebundener
Ösenplatte
(Ø 11,5 mm)

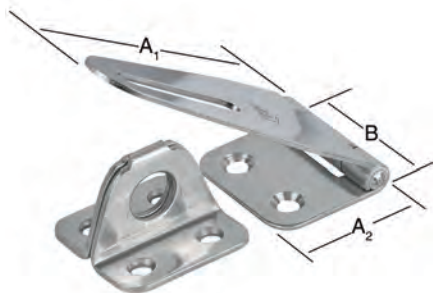

Stck./Karte
1

Draht- Überfallen

mit angebundener
Ösenplatte

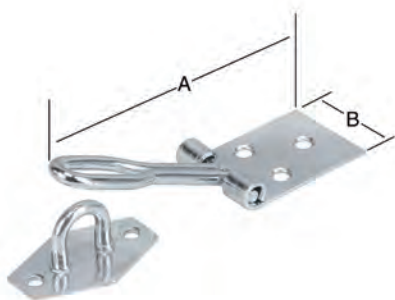

| Artikel-Nr. | Ausführung | GTIN 4003984 | Abmessungen mm | | | ca. kg je VE | Schrauben | | verp. zu... Stck. |
|-------------|------------|-----------------|-------------------|----|--------|--------------------|------------|------------|-------------------------|
| | | | A | B | Stärke | | Stck. | Ø mm | |
| 000025200Z | | 080729 | 140 60 | 50 | 3,0 | 1,72 | 4/4 1 □ | 6,0 8,0 | 5 |

| | | | | | | | | | |
|-----------|--|--------|----------|----|-----|------|--------|------------|---|
| 010090080 | | 180078 | 80 30 | 37 | 1,5 | 0,41 | 2 4 | 4,0 3,5 | 5 |
| 091977000 | | 510240 | 80 30 | 37 | 1,5 | 0,52 | 2 4 | 4,0 3,5 | 5 |

| | | | | | | | | | |
|------------|--|--------|-----|----|-----|------|---|-----|----|
| 000080080Z | | 080408 | 80 | 22 | 1,3 | 0,22 | 5 | 2,5 | 10 |
| 000080100Z | | 080415 | 100 | 30 | 1,3 | 0,48 | 5 | 3,0 | 10 |
| 000081120Z | | 080439 | 120 | 34 | 1,5 | 0,61 | 5 | 3,0 | 10 |
| 000081140Z | | 080446 | 140 | 38 | 1,5 | 0,77 | 5 | 3,0 | 10 |

| Artikel-Nr. | Ausführung | GTIN 4003984 | Abmessungen mm | | | ca. kg je VE | Schrauben | | verp. zu... Stck. |
|-------------|------------|-----------------|-------------------|----|--------|--------------------|-----------|------|-------------------------|
| | | | A | B | Stärke | | Stck. | Ø mm | |
| 090841000 | V | 550222 | 47 | 20 | 0,5 | 0,16 | - | - | 5 |

Schattellen-Überfallen

mit Ösenplatte
(inkl. Nägel und
Schrauben)

vermessingt

Stck./Karte
1

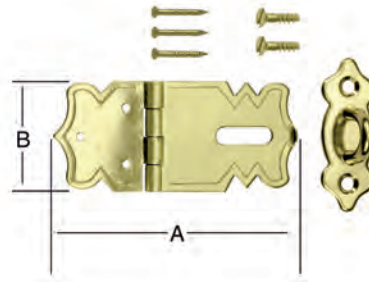

| | | | | | | | | | |
|-----------|---|--------|----|----|---|------|---|---|---|
| 090837000 | V | 550048 | 30 | 19 | - | 0,17 | - | - | 5 |
|-----------|---|--------|----|----|---|------|---|---|---|

Schattellen-Verschlüsse

(inkl. Nägel)

vermessingt

Stck./Karte
2

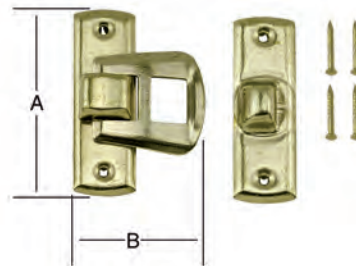

| | | | | | | | | | |
|-----------|---|--------|----|----|---|------|---|---|---|
| 090835000 | V | 550031 | 25 | 15 | - | 0,14 | - | - | 5 |
|-----------|---|--------|----|----|---|------|---|---|---|

Schattellen-Verschlüsse

(inkl. Nägel)

vermessingt

Stck./Karte
2

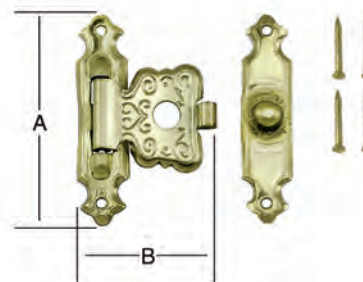



Ösenplatten/Vorreiber

Eyelet plates / Casement fasteners
Plaques à œillets / Manettes pivotantes
Placas con ojete / Aldabillas

Ösenplatten

für Überfallen und
Stallanwürfe

für Überfallen

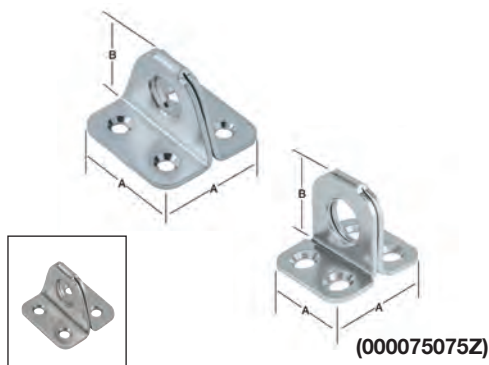

Ösenplatten

für Drahtüberfallen

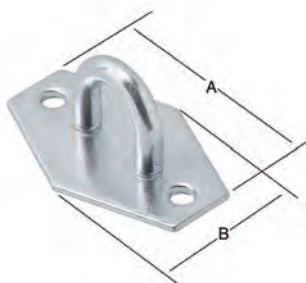

Vorreiber auf Platte

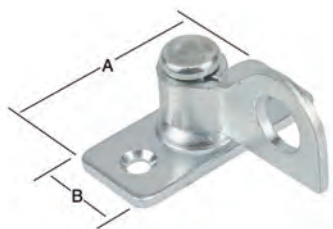

Haken (Klavier- haken)

mit Öse und Schraube
vermessingt

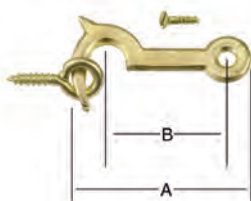

Stck./Karte
4

| Artikel-Nr. | Ausführung | GTIN 4003984 | Abmessungen mm | | | ca. kg je VE | Schrauben | | verp. zu... Stck. |
|-------------|--|-----------------|-------------------|----|--------|--------------------|-----------|------|-------------------------|
| | | | A | B | Stärke | | Stck. | Ø mm | |
| 000075035Z | | 080361 | 35 | 25 | 2,0 | 0,78 | 4 | 3,5 | 25 |
| 000075075Z | | 080378 | 45 | 42 | 2,5 | 0,36 | 4 | 6,0 | 5 |
| 010075035 |  V2A | 180351 | 35 | 25 | 2,0 | 0,62 | 4 | 3,5 | 20 |
| 000076040Z | | 080385 | 40 | 28 | 1,25 | 0,39 | 2 | 3,0 | 25 |
| 000076045Z | | 080392 | 45 | 31 | 1,25 | 0,62 | 2 | 3,0 | 25 |
| 000243020Z | | 160223 | 45 | 20 | 2,5 | 0,83 | 2 | 4,0 | 20 |
| 090839000 | V | 460446 | 30 | 16 | - | 0,29 | 1 | 2,0 | 10 |

| Artikel-Nr. | Ausführung | GTIN 4003984 | Abmessungen mm | | | ca. kg je VE | Schrauben | | verp. zu... Stck. |
|-------------|------------|-----------------|-------------------|---|--------|--------------------|-----------|------|-------------------------|
| | | | A | B | Stärke | | Stck. | Ø mm | |

| | | | | | | | | | |
|------------|---|--------|-----|---|-----|------|---|---|----|
| 000082060Z | | 290562 | 60 | - | 3,5 | 0,30 | - | - | 25 |
| 000082080Z | | 290555 | 80 | - | 3,9 | 0,58 | - | - | 25 |
| 000082100Z | | 290548 | 100 | - | 4,0 | 0,59 | - | - | 25 |
| 000082120Z | | 290579 | 120 | - | 4,2 | 0,74 | - | - | 25 |
| 000082160Z | | 290531 | 160 | - | 5,2 | 0,55 | - | - | 10 |
| 000082200Z | | 290524 | 200 | - | 6,0 | 0,94 | - | - | 10 |
| 000082300Z | | 080804 | 300 | - | 6,0 | 0,93 | - | - | 10 |
| 000082400Z | | 080811 | 400 | - | 6,0 | 0,64 | - | - | 5 |
| 000082500Z | | 080828 | 500 | - | 7,0 | 1,05 | - | - | 5 |
| 010082080 |  | 180658 | 80 | - | 3,9 | 0,47 | - | - | 20 |
| 010082120 | | 180665 | 120 | - | 4,2 | 0,65 | - | - | 20 |

| | | | | | | | | | |
|------------|--|--------|-----|----|-----|------|---|-----|----|
| 000083100Z | | 290500 | 100 | 43 | 5,2 | 0,57 | 4 | 3,0 | 10 |
| 000083120Z | | 290494 | 120 | 43 | 5,8 | 0,66 | 4 | 3,0 | 10 |
| 000083200Z | | 290722 | 200 | 35 | 6,0 | 0,61 | 8 | 3,5 | 5 |
| 000083250Z | | 290739 | 250 | 35 | 6,0 | 0,66 | 8 | 3,5 | 5 |

| | | | | | | | | | |
|------------|--|--------|----|----|---|------|---|---|---|
| 000097001Z | | 370165 | 98 | 45 | - | 1,05 | - | - | 5 |
|------------|--|--------|----|----|---|------|---|---|---|

| | | | | | | | | | |
|------------|--|--------|-----|----|---|------|---|---|----|
| 000097002Z | | 370172 | 128 | 45 | - | 2,66 | - | - | 10 |
|------------|--|--------|-----|----|---|------|---|---|----|

| | | | | | | | | | |
|------------|--|--------|---|-----|---|------|---|---|---|
| 000292050Z | | 370196 | - | 50 | - | 1,61 | - | - | 4 |
| 000292100Z | | 370202 | - | 100 | - | 2,42 | - | - | 4 |
| 000292120Z | | 370189 | - | 120 | - | 2,77 | - | - | 4 |

Sturmhaken/Barrenringe

Window stays / Pulley blocks with loop
Crochets de contrevent / Anneaux d'écurie
Ganchos para ventanas / Goznes con ojete

Sturmhaken mit Öse

Alle zusammengehörenden Teile sind miteinander verbunden.

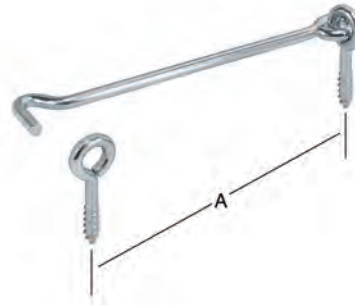

Sturmhaken mit Öse auf Platte

Alle zusammengehörenden Teile sind miteinander verbunden.

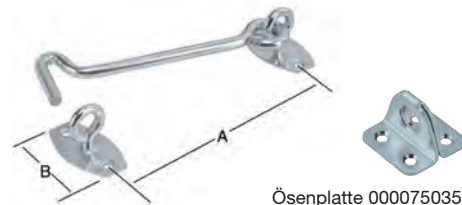

Ösenplatte 000075035Z
ab Art-Nr. 000083200Z

Barrenringe mit Holzgewinde

bitte nicht für Schaukeln verwenden!

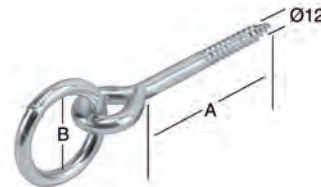

Barrenringe mit metrischen Gewinde

bitte nicht für Schaukeln verwenden!

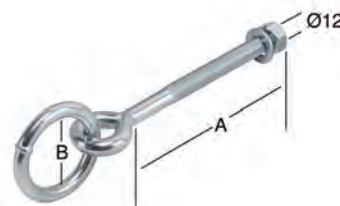

Manschettenhaken

bitte nicht für Schaukeln verwenden!

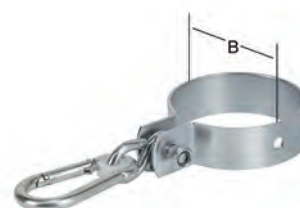

Torbeschläge

Gate fittings
Ferrures de portails
Herrajes para puertas

Gitterrost-sicherungen mit Ringschrauben



Stck./Karte
1



| Artikel-Nr. | Ausführung | GTIN 4003984 | Abmessungen mm | | | ca. kg je VE | Schrauben | | verp. zu... Stck. |
|-------------|------------|-----------------|-------------------|----|--------|--------------------|-----------|------|-------------------------|
| | | | A | B | Stärke | | Stck. | Ø mm | |
| 090480000 | Z | 430043 | 415 | 20 | 3,0 | 0,37 | - | - | 10 |

Gartentor-fallen Typ 1 mit angebundenem Klinkhaken, rechts und links verwendbar

Verstellbereich 40 mm



Stck./Karte
1

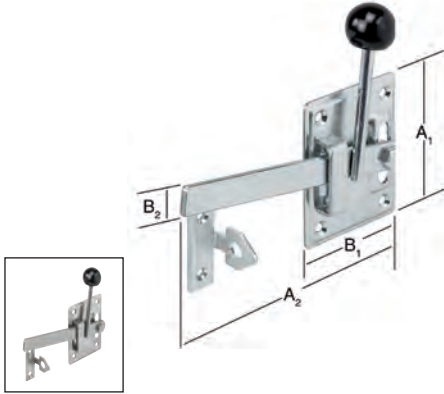

| | | | | | | | | | |
|------------|-----|--------|------------|----------|------------|------|--------|------------|----|
| 000085000Z | | 601535 | 100 183 | 80 20 | 2,0 5,0 | 3,83 | 4 2 | 4,5 5,0 | 10 |
| 010085000 | V2A | 510608 | 100 183 | 80 20 | 2,0 5,0 | 0,35 | 4 2 | 4,5 5,0 | 1 |
| 092236000 | Z | 430173 | 100 183 | 80 20 | 2,0 5,0 | 0,39 | 4 2 | 4,5 5,0 | 1 |

Gartentor-fallen Typ 2 mit angebundenem Klinkhaken, für schmale Rahmenhöhen rechts und links verwendbar

Verstellbereich 30 mm

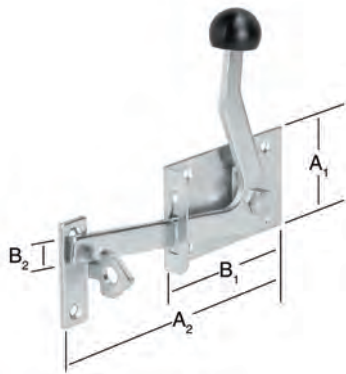

| | | | | | | | | | |
|------------|--|--------|-----------|----------|------------|------|--------|------------|---|
| 000085001Z | | 601443 | 60 155 | 82 16 | 2,0 5,0 | 0,25 | 4 2 | 4,5 5,0 | 1 |
|------------|--|--------|-----------|----------|------------|------|--------|------------|---|

Doppeltor-überwürfe rechts und links verwendbar

Bolzen doppelt gelagert



Stck./Karte
1

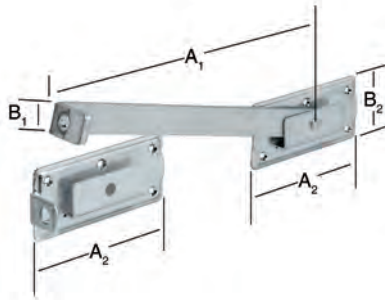

| | | | | | | | | | |
|------------|---|--------|------------|----------|-----|------|----|-----|---|
| 000086000Z | | 601542 | 340 180 | 30 70 | 3,0 | 6,91 | 10 | 4,5 | 5 |
| 092248000 | Z | 430203 | 340 180 | 30 70 | 3,0 | 1,36 | 10 | 4,5 | 1 |

Edelstahl-Doppeltor-überwürfe rechts und links verwendbar

Bolzen doppelt gelagert

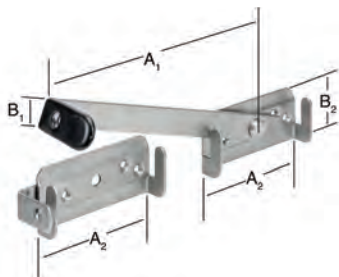

| | | | | | | | | | |
|-----------|-----|--------|------------|----------|-----|------|---|-----|---|
| 010084000 | V2A | 180634 | 250 115 | 25 55 | 2,0 | 0,72 | 8 | 6,0 | 1 |
|-----------|-----|--------|------------|----------|-----|------|---|-----|---|

Torbeschläge/Torfeststeller

Gate fittings / Gate stopping devices
 Ferrures de portails / Cale-portes
 Herrajes para puertas / Bloqueos de puerta

Universal-Kasten-schlösser

Schloß und Zubehör
 sendzimir verzinkt

Drücker:
 Kunststoff schwarz

Alle zusammengehörenden Teile sind miteinander verbunden.

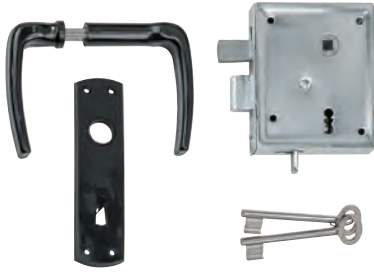

| Artikel-Nr. | GTIN 4003984 | Abmessungen | | | | ca. kg je VE | Schrauben | | VE |
|-------------|-----------------|-------------|---|---|---|--------------------|-----------|------|----|
| | | A | B | C | D | | Stck. | Ø mm | |
| 092235000 | 430166 | - | - | - | - | 0,88 | - | - | 1 |

Tortreibriegel mit Rundstangen

- für Flügeltore bis
 2550 mm Höhe

- Treibstangen (Voll-
 material Ø 12 mm)
 beliebig kürzbar

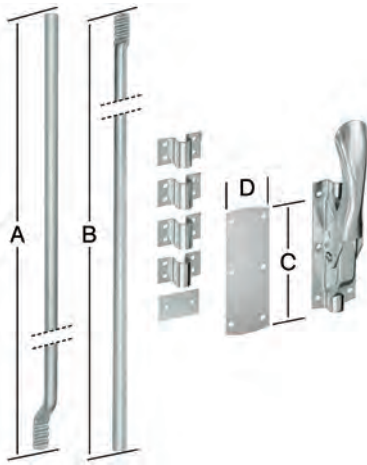

| Artikel-Nr. | GTIN | A | B | C | D | ca. kg je VE | Stck. | Ø mm | VE |
|-------------|--------|------|------|-----|----|--------------------|-------|------|----|
| 001120000Z | 790031 | 1400 | 1200 | 125 | 45 | 2,57 | - | - | 1 |

Sicherheits-Standardriegel

Mit deutlichen Pluspunkten:

- kompakte Sicherheit
- innovative Technik
- extra stabiler Schieber (4 mm)

Geschlossene Riegelstellung:

Sicherheit durch verdeckte Schraublöcher



Montagestellung:

offene Schraublöcher in Riegel und Schlaufe



Sicherheits-Standard-riegel mit angebundener Schlaufe

mit angebundener
 Schlaufe

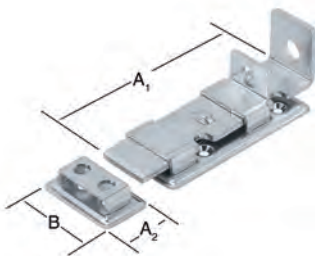

| Artikel-Nr. | Ausführung | GTIN 4003984 | Abmessungen mm | | | ca. kg je VE | Schrauben | | verp. zu... Stck. |
|-------------|---------------------|-----------------|-------------------|----|--------|--------------------|-----------|------------|-------------------------|
| | | | A | B | Stärke | | Stck. | Ø mm | |
| 000100120Z | gerade, verzinkt | 600446 | 120 28 | 48 | 1,75 | 1,39 | 4 2 | 4,0 4,0 | 5 |
| 000100140Z | gerade, verzinkt | 603027 | 150 28 | 48 | 1,75 | 1,67 | 4 2 | 4,0 4,0 | 5 |
| 000100160Z | gerade, verzinkt | 603003 | 160 35 | 60 | 2,5 | 0,55 | 4 2 | 5,0 5,0 | 1 |
| 000100120BR | gerade, brüniert | 600453 | 120 28 | 48 | 1,75 | 1,41 | 4 2 | 4,0 4,0 | 5 |

| Artikel-Nr. | Ausführung | GTIN 4003984 | Abmessungen mm | | | ca. kg je VE | Schrauben | | verp. zu... Stck. |
|-------------|------------|-----------------|-------------------|---|--------|--------------------|-----------|------|-------------------------|
| | | | A | B | Stärke | | Stck. | Ø mm | |

| | | | | | | | | | |
|------------|--|--------|------------|----|------|------|--------------|-----|---|
| 000214140Z | | 602228 | 135 100 | 70 | 1,50 | 2,07 | 4 rd. 2 □ | 4,5 | 6 |
|------------|--|--------|------------|----|------|------|--------------|-----|---|

Riegel und Schlaufen

Bolts and bolt loops
Targettes et pattes à gâche
Cerrojos y argollas para cerrojos

Bolzen-Schließriegel

mit angebundener
Schlaufe

Bolzen Ø 15 mm

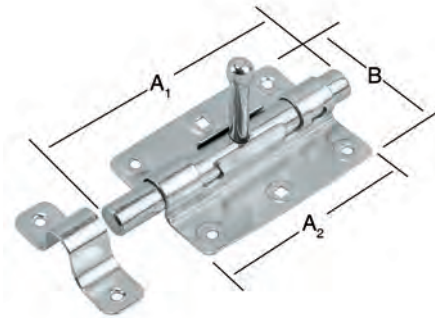

| | | | | | | | | | |
|------------|--|--------|-----|----|-----|------|---|-----|----|
| 000226080Z | | 601948 | 75 | 30 | 1,2 | 0,56 | 7 | 3,5 | 10 |
| 000226100Z | | 600583 | 98 | 30 | 1,2 | 0,84 | 7 | 4,0 | 10 |
| 000226130Z | | 600590 | 125 | 30 | 1,2 | 1,29 | 9 | 4,5 | 10 |

Grendelriegel

mit kombinierter
Schlaufe

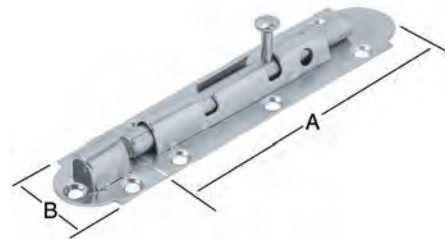

| | | | | | | | | | |
|------------|--|--------|----|----|-----|------|---|-----|----|
| 000101040Z | | 600439 | 39 | 82 | 1,5 | 0,75 | 6 | 3,5 | 10 |
| 000101047Z | | 600477 | 45 | 85 | 1,5 | 1,07 | 6 | 3,5 | 10 |

Feder-Grendelriegel

mit Schlaufe,
mit Messing-Knopf

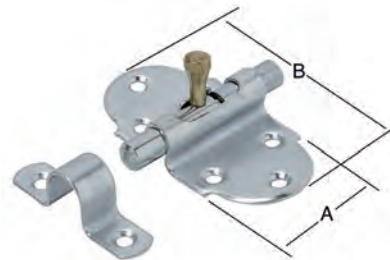

| | | | | | | | | | |
|-----------|---|--------|----|----|------|------|---|-----|---|
| 091948000 |  | 510158 | 55 | 35 | 1,25 | 0,41 | 6 | 3,0 | 5 |
|-----------|---|--------|----|----|------|------|---|-----|---|

Grendelriegel

mit Schlaufe



Stck./Karte
1

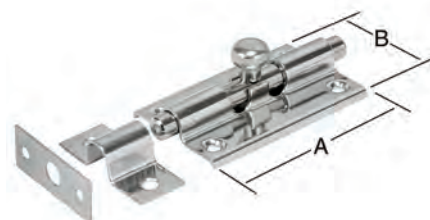

- Bewährte Technik
- Höhere Stabilität
- Modernes Design



Alte Riegelform

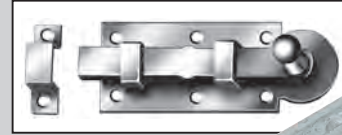

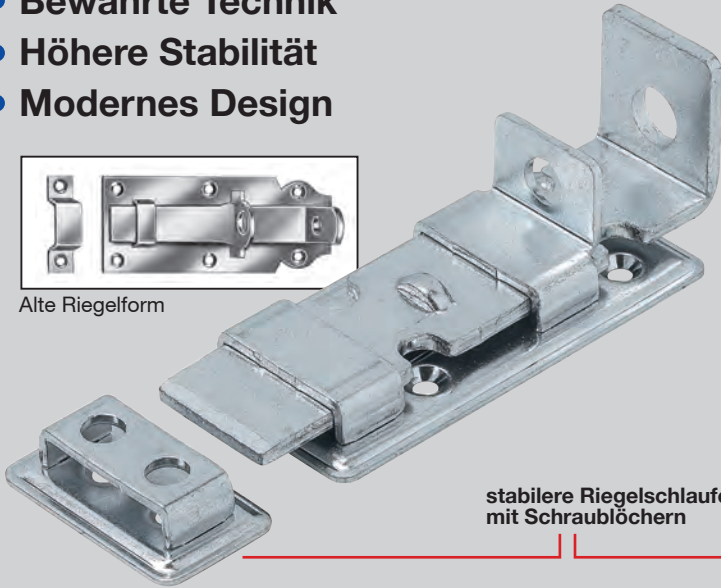

Alte Riegelform

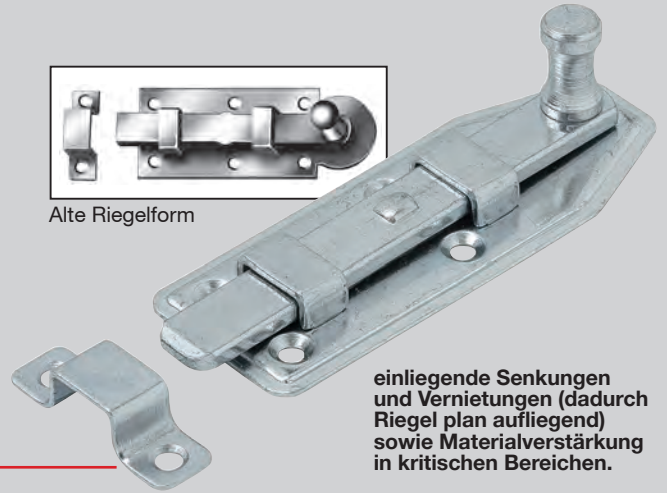

stabilere Riegelschleife mit Schraublöchern



einliegende Senkungen und Vernietungen (dadurch Riegel plan aufliegend) sowie Materialverstärkung in kritischen Bereichen.

| Artikel-Nr. | Ausführung | GTIN 4003984 | Abmessungen mm | | | ca. kg je VE | Schrauben | | verp. zu... Stck. |
|-------------|---|-----------------|-------------------|----|--------|--------------------|-----------|------|-------------------------|
| | | | A | B | Stärke | | Stck. | Ø mm | |
| 000102040Z | | 601795 | 40 | 22 | 1,0 | 0,26 | 5 | 2,5 | 20 |
| 000102060Z | | 600040 | 60 | 25 | 1,2 | 0,37 | 5 | 2,5 | 10 |
| 000102080Z | | 600057 | 80 | 30 | 1,2 | 0,61 | 5 | 3,0 | 10 |
| 000102100Z | | 600064 | 100 | 35 | 1,2 | 0,84 | 5 | 3,0 | 10 |
| 000102120Z | | 601764 | 120 | 35 | 1,2 | 0,96 | 5 | 3,0 | 10 |
| 010102080 |  | 180429 | 80 | 30 | 1,0 | 0,55 | 5 | 3,0 | 10 |
| 010102100 | | 180467 | 100 | 35 | 1,0 | 0,38 | 5 | 3,0 | 5 |
| 092198000 | Z | 430814 | 40 | 22 | 1,0 | 0,21 | 5 | 2,5 | 5 |
| 091946000 |  | 510615 | 80 | 30 | 1,0 | 0,37 | 5 | 2,5 | 5 |

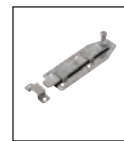
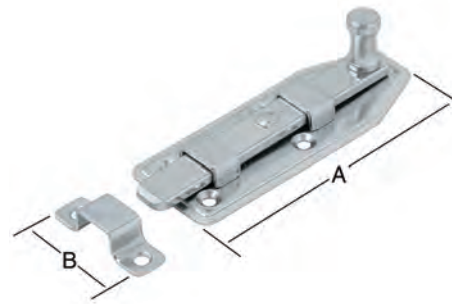

Fensterriegel

gerade, mit angebundener Schleife



Stck./Karte
2

1

| | | | | | | | | | |
|------------|--|--------|-----|----|-----|------|---|-----|----|
| 000103060Z | | 600484 | 60 | 25 | 1,2 | 0,40 | 5 | 2,5 | 10 |
| 000103080Z | | 600071 | 80 | 30 | 1,2 | 0,58 | 5 | 3,0 | 10 |
| 000103100Z | | 600491 | 100 | 35 | 1,2 | 0,83 | 5 | 3,0 | 10 |

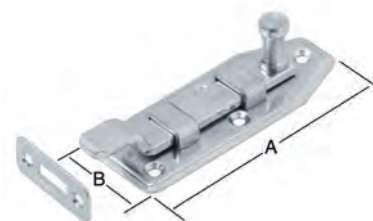

Fensterriegel

gekröpft, mit angebundenem Schließblech



Riegel und Schlaufen

Bolts and bolt loops
Targettes et pattes à gâche
Cerrojos y argollas para cerrojos

Türschloss-riegel

gerade, mit
angebundener
Schlaufe

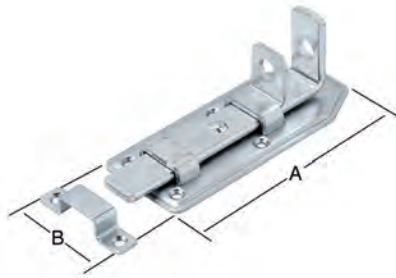

| Artikel-Nr. | Ausführung | GTIN 4003984 | Abmessungen mm | | | ca. kg je VE | Schrauben | | verp. zu... Stck. |
|-------------|-----------------|-----------------|-------------------|----|--------|--------------------|-----------|------|-------------------------|
| | | | A | B | Stärke | | Stck. | Ø mm | |
| 000105100Z | | 600101 | 100 | 50 | 1,5 | 1,80 | 4 | 4,0 | 10 |
| 000105120Z | | 600118 | 120 | 56 | 2,0 | 2,90 | 5 | 4,0 | 10 |
| 000105140Z | | 600125 | 140 | 56 | 2,0 | 3,23 | 5 | 4,0 | 10 |
| 000105160Z | | 600132 | 160 | 65 | 2,5 | 2,76 | 5 | 5,0 | 5 |
| 000105180Z | | 600149 | 180 | 65 | 2,5 | 3,02 | 5 | 5,0 | 5 |
| 010105120 | Rostfrei V2A | 180436 | 120 | 56 | 1,5 | 1,14 | 5 | 4,0 | 5 |
| 010105140 | | 180474 | 140 | 56 | 1,5 | 1,31 | 5 | 4,0 | 5 |

Türschloss-riegel

geköpft, mit
angebundenem
Schließblech

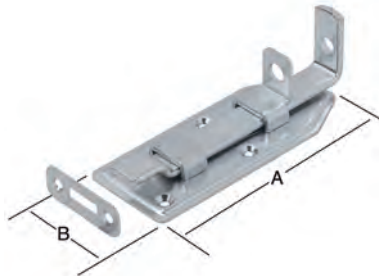

| | | | | | | | | | |
|------------|--|--------|-----|----|-----|------|---|-----|----|
| 000106100Z | | 600156 | 100 | 50 | 1,5 | 0,87 | 4 | 4,0 | 5 |
| 000106120Z | | 600163 | 120 | 56 | 2,0 | 1,37 | 5 | 4,0 | 5 |
| 000106140Z | | 600170 | 140 | 56 | 2,0 | 3,09 | 5 | 4,0 | 10 |
| 000106160Z | | 600187 | 160 | 65 | 2,5 | 2,78 | 5 | 5,0 | 5 |
| 000106180Z | | 600521 | 180 | 65 | 2,5 | 3,03 | 5 | 5,0 | 5 |

Türknopf-riegel

gerade, mit
angebundener
Schlaufe

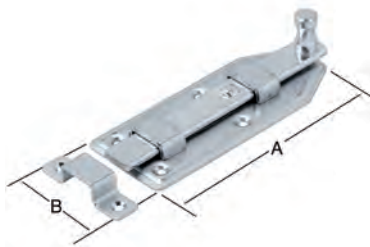

| | | | | | | | | | |
|------------|--|--------|-----|----|-----|------|---|-----|----|
| 000107100Z | | 600194 | 100 | 50 | 1,5 | 1,73 | 4 | 4,0 | 10 |
| 000107120Z | | 600200 | 120 | 56 | 2,0 | 2,70 | 4 | 4,0 | 10 |
| 000107140Z | | 600217 | 140 | 56 | 2,0 | 3,04 | 5 | 4,0 | 10 |
| 000107160Z | | 600224 | 160 | 65 | 2,5 | 2,68 | 5 | 5,0 | 5 |
| 000107180Z | | 601658 | 180 | 65 | 2,5 | 2,91 | 5 | 5,0 | 5 |

Türknopf-riegel

geköpft,
mit angebundenem
Schließblech

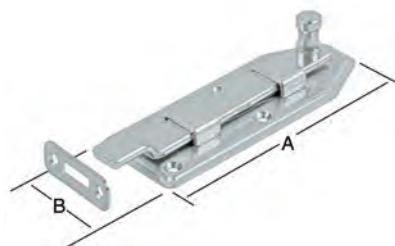

| | | | | | | | | | |
|------------|--|--------|-----|----|------|------|---|-----|----|
| 000107101Z | | 601634 | 100 | 50 | 1,75 | 1,80 | 4 | 4,0 | 10 |
| 000107121Z | | 601603 | 120 | 56 | 2,0 | 2,66 | 4 | 4,0 | 10 |
| 000107141Z | | 601573 | 140 | 56 | 2,0 | 2,96 | 5 | 4,0 | 10 |

| Artikel-Nr. | Ausführung | GTIN 4003984 | Abmessungen mm | | | ca. kg je VE | Schrauben | | verp. zu... Stck. |
|-------------|------------|-----------------|-------------------|----|--------|--------------------|-----------|------|-------------------------|
| | | | A | B | Stärke | | Stck. | Ø mm | |
| 000110160Z | | 601849 | 160 | 70 | 2,5 | 3,37 | 6 | 4,5 | 5 |
| 000110180Z | | 600255 | 180 | 80 | 2,5 | 4,58 | 6 | 4,5 | 5 |

Riegel und Schlaufen

Bolts and bolt loops
Targettes et pattes à gâche
Cerrojos y argollas para cerrojos

Schwere Rollen- Schlossriegel

gerade,
mit angebundener
Schlaufe,
mit gedrehten Rollen

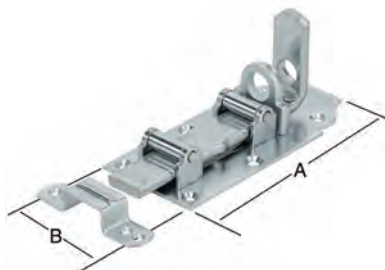

| | | | | | | | | | |
|------------|--|--------|-----|-----------|---|------|-------|-----|---|
| 000111400Z | | 600279 | 400 | 100 65 | 2 | 2,80 | 4 rd. | 4,5 | 5 |
| 000111500Z | | 600545 | 500 | 100 65 | 2 | 2,90 | 4 rd. | 4,5 | 5 |
| 000111600Z | | 600712 | 600 | 100 65 | 2 | 3,12 | 4 rd. | 4,5 | 5 |

Bolzen- Stangenriegel

mit angebundener
Schlaufe und
Schließblech

Bolzen Ø 16 mm

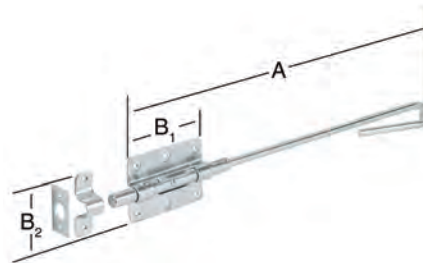

| | | | | | | | | | |
|-------------|--|--------|-----|----|-----|------|---|-----|---|
| 000109160ZF | | 600248 | 160 | 65 | 2,5 | 0,62 | 5 | 4,5 | 1 |
| 000109180ZF | | 600538 | 180 | 65 | 2,5 | 3,41 | 5 | 4,5 | 5 |

Bolzenriegel

mit angebundener
Schlaufe

Bolzen Ø 16 mm

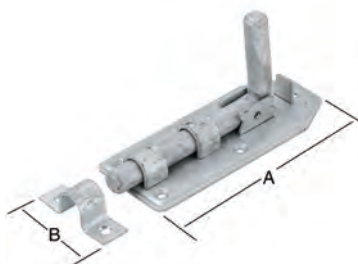

| | | | | | | | | | |
|-------------|--|--------|-------------------|----|-----|------|---|-----|---|
| 000108200ZF | | 600231 | 200 265 130 | 65 | 4,5 | 3,88 | 6 | 6,0 | 5 |
|-------------|--|--------|-------------------|----|-----|------|---|-----|---|

Sicherheits- Stallriegel

mit angebundener
Schlaufe,
mit verdeckter
Sperrklinke

Bolzen Ø 15 mm

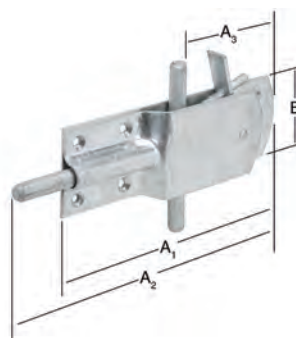

Riegelschlaufen / Oberlichtschnäpper

Bolt loops / Skylight catches
 Pattes à gâche / Loqueteaux pour vasistas
 Argollas para cerrojos / Pestillos de tragaluz

Stalltür-Schlossriegel

mit angebundener Schlaufe,
 mit losem Stift,
 100 mm lang,
 mit Gewinde,
 zum Einschrauben in
 die Rückseite des
 Schiebers.

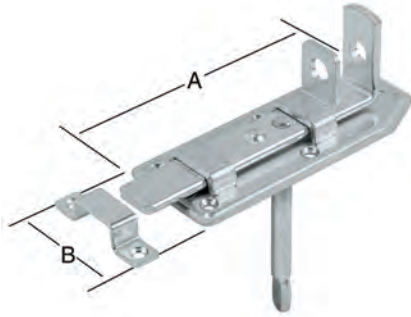

| Artikel-Nr. | Ausführung | GTIN 4003984 | Abmessungen mm | | | ca. kg je VE | Schrauben | | verp. zu... Stck. |
|-------------|------------|-----------------|-------------------|----|--------|--------------------|-----------|------|-------------------------|
| | | | A | B | Stärke | | Stck. | Ø mm | |
| 000105001Z | | 600644 | 160 | 65 | 2,5 | 3,19 | 6 | 5,0 | 5 |
| 000105002Z | | 600651 | 180 | 65 | 2,5 | 3,41 | 6 | 5,0 | 5 |

Riegel-schlaufen

mit Vierkantlöchern

passend für Riegel
 000109160ZF
 000109180ZF
 000111400Z
 000111500Z
 000111600Z

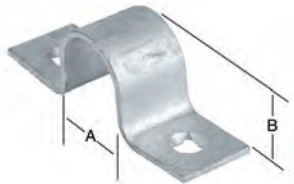

| | | | | | | | | | |
|-------------|--|--------|----|----|-----|------|---|-----|----|
| 000169018ZF | | 201278 | 18 | 24 | 2,0 | 1,51 | 2 | 5,0 | 50 |
|-------------|--|--------|----|----|-----|------|---|-----|----|

Riegel-schlaufen

mit Schraublöchern



| | | | | | | | | | |
|------------|--|--------|----|------|-----|------|---|-----|-----|
| 000170014Z | | 201872 | 14 | 7 | 1,2 | 0,54 | 2 | 2,5 | 100 |
| 000170020Z | | 200059 | 20 | 11,5 | 2,0 | 0,41 | 2 | 4,0 | 25 |
| 000170025Z | | 200066 | 25 | 12 | 2,0 | 0,50 | 2 | 4,0 | 25 |
| 000170030Z | | 201803 | 30 | 14 | 2,5 | 0,69 | 2 | 5,0 | 25 |
| 000170034Z | | 200073 | 34 | 16 | 2,5 | 1,26 | 4 | 5,0 | 25 |

passend für Riegel

| | |
|------------|---|
| 000170014Z | 000102100Z / 000102120Z |
| 000170020Z | 000105100Z / 000107100Z |
| 000170025Z | 000105120Z / 000105140Z / 000107120Z / 000107140Z |
| 000170030Z | 000105160Z / 000105180Z / 000107160Z / 000107180Z |
| 000170034Z | 000110180Z |

Oberlicht-schnäpper

leicht,
 mit Schraubhaken

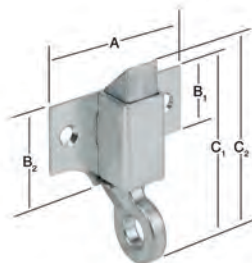

| | | | | | | | | | |
|------------|--|--------|----|-----------|-----------|------|---|-----|----|
| 000239001Z | | 602082 | 46 | 21/ 29 | 50/ 60 | 1,42 | 2 | 3,0 | 20 |
|------------|--|--------|----|-----------|-----------|------|---|-----|----|

Oberlicht-schnäpper

schwer,
 mit Schraubhaken

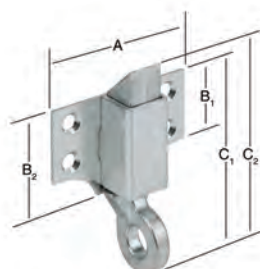

| | | | | | | | | | |
|------------|--|--------|----|-----------|-----------|------|---|-----|----|
| 000239002Z | | 601979 | 53 | 28/ 36 | 61/ 66 | 2,20 | 4 | 4,5 | 20 |
|------------|--|--------|----|-----------|-----------|------|---|-----|----|

Window- and door-protection
Verrou de sécurité pour fenêtres et portes
Cerrojo de seguridad para ventanas y puertas

Leicht nachrüstbar

- Problemlose und sichere Montage.
- Bei Verwendung entsprechender handelsüblicher Montagetechnik ist die Befestigung des Beschlages auch auf **Kunststoff** und **Aluminium** möglich.
- Beide Größen der Fenster- und Türsicherung können mittels beigefügter Distanzplatten **jeder Falzstärke** angepaßt werden.
- Ausschließlich Befestigung auf Rahmen. **Sonst übliche zusätzliche Montage auf Flügel entfällt.**
- Der Beschlag ist durch seine geringe Aufbauhöhe und kompakte Form von außen **nicht sichtbar**.

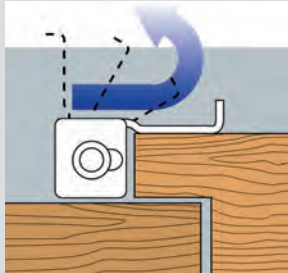

Einfache Funktion:

Öffnen:
Verriegelung vorziehen und um 90° abklappen.

Schließen:
Verriegelung zurückklappen. Das Einrasten erfolgt automatisch.



Fenster-
sicherung
geöffnet



Fenster-
sicherung
geschlossen
(Verriegelungs-
position)





Einbruchhemmung
leicht nachrüstbar

In der entsprechenden Höhe angebracht, dient die Fenster- und Türsicherung zusätzlich als **Kindersicherung**.

Eine wirkungsvolle Sicherungsmaßnahme

für alle nach innen zu öffnenden Hebetüren sowie ein- und zweiflügelige Fenster und Türen.



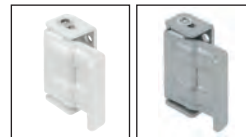
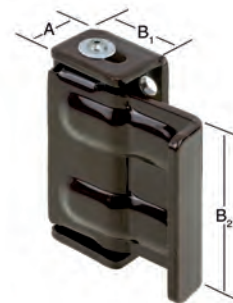

| Artikel-Nr. | Ausführung | GTIN 4003984 | Abmessungen mm | | | ca. kg je VE | Schrauben ..Stck. | Distanz- platten ..Stck. | verp. zu... Stck. |
|-------------|------------|-----------------|--|----|--------|--------------------|----------------------|--------------------------------|-------------------------|
| | | | A | B | Stärke | | | | |
| 000201016B | B | 603034 | 16-25 | 24 | 3,0 | 1,89 | 2 | 3 | 10 |
| 000201016W | W | 603041 |  1A | 62 | 3,0 | 1,89 | 2 | 3 | 10 |
| 091088000 | B | 440561 | 16-25 | 24 | 3,0 | 1,99 | 2 | 3 | 10 |
| 091089000 | W | 603164 |  1A | 62 | 3,0 | 1,99 | 2 | 3 | 10 |
| 091091000 | WA | 603126 |  1A | 62 | 3,0 | 1,99 | 2 | 3 | 10 |



Kleine Fenster- und Türsicherung



Stck./Karte
1

| | | | | | | | | | |
|-------------|----|--------|--|----|-----|------|---|---|----|
| 000204016B | B | 603096 | 16-25 | 27 | 3,0 | 3,26 | 4 | 3 | 10 |
| 000204016W | W | 603102 |  1A | 92 | 3,0 | 3,26 | 4 | 3 | 10 |
| 000204016WA | WA | 603157 |  1A | 92 | 3,0 | 3,26 | 4 | 3 | 10 |
| 091104000 | B | 603218 | 16-25 | 27 | 3,0 | 3,39 | 4 | 3 | 10 |
| 091105000 | W | 603225 |  1A | 92 | 3,0 | 3,39 | 4 | 3 | 10 |
| 091103000 | WA | 603133 |  1A | 92 | 3,0 | 3,39 | 4 | 3 | 10 |

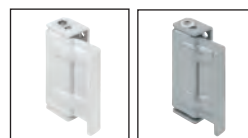

Große Fenster- und Türsicherung



Stck./Karte
1

Fenster- und Türsicherungen sind inklusive:
Schrauben DIN 7981 5,5 x 48 mm und Distanzplatten 2,3 + 4 mm.
Die beigefügten Distanzplatten gestatten im Bedarfsfall einen zusätzlichen
Ausgleich der Aufschlaghöhen von 16 - 25 mm.

2.3 Kistenbeschläge

Chest hinges
Ferrures des coffres
Herrajes para cajas

Seite
page
page
pagina



D



GB



F



E

| | | | | |
|-------|------------------------------------|---------------------------------|---|--|
| 37-38 | Spannverschlüsse / Schließhaken | Chest locks / Locking hooks | Fermeurs de coffre à levier / Pattes pour fermeurs de coffre | Cierres de caja / Ganchos de cierre de caja |
| 39 | Kistenbänder | Case hinges | Pentures de coffre | Bisagras para cajas |
| 40 | Edelstahlbänder | Stainless steel hinges | Pentures en acier inoxydable | Bisagras de acero inoxidable |
| 41-42 | Kistengriffe / Kistenecken | Case handles / Chest corners | Poignées de coffres / Coins de coffre | Asas para cajones / Cantoneiras para cajas |



| Artikel-Nr. | Ausführung | GTIN 4003984 | Abmessungen mm | | | | ca. kg je VE | Schrauben | | verp. zu... Stck. | Passende Schließhaken DIN-Form G = Nr. 8 DIN-Form K = Nr. 9 G = gerade K = gekröpft | |
|-------------|---------------------|-----------------|-------------------|----|-----|------|--------------------|-----------|-------|-------------------------|---|------------|
| | | | A | B | C | Höhe | | Stck. | Ø mm | | 000008015Z | 000009015Z |
| 001202050Z | | 160247 | 52 | 23 | Ø 3 | 11 | 0,96 | 2 | 2,5/3 | 50 | 000008015Z | 000009015Z |
| 001202070Z | | 160254 | 70 | 31 | Ø 4 | 13 | 2,30 | 2 | 3/4 | 50 | 000008115Z | 000009018Z |
| 001202085Z | | 160261 | 87 | 33 | Ø 4 | 15 | 3,07 | 2 | 3/4 | 50 | 000008018Z | 000009018Z |
| 001202105Z | | 160285 | 110 | 37 | Ø 4 | 12 | 2,02 | 3 | 4,0 | 25 | 000008025Z | 000009025Z |
| 001202130Z | | 160292 | 138 | 47 | Ø 5 | 22 | 4,29 | 3 | 5 | 25 | 000008030Z | 000009030Z |
| 011202050 | ROST FREI V2A | 180245 | 52 | 23 | Ø 3 | 11 | 0,39 | 2 | 2,5/3 | 20 | 010008115 | 010009015 |
| 011202070 | | 180252 | 70 | 31 | Ø 4 | 13 | 0,94 | 2 | 3/4 | 20 | 010008018 | 010009018 |
| 011202105 | | 180269 | 110 | 37 | Ø 4 | 12 | 1,63 | 3 | 4,0 | 20 | 010008025 | 010009025 |
| 092264000 | Z | 430272 | 52 | 23 | Ø 3 | 11 | 0,26 | 2 | 2,5/3 | 5 | mit gekröpften Schließhaken | |
| 092265000 | Z | 430289 | 70 | 31 | Ø 4 | 13 | 0,39 | 2 | 3/4 | 5 | | |
| 091964000 | ROST FREI V2A | 510226 | 52 | 23 | Ø 3 | 11 | 0,25 | 2 | 2,5/3 | 5 | mit gekröpften Schließhaken | |

Spannverschlüsse

Chest locks
Ferroirs de coffre à levier
Cierres de caja



Spann- verschlüsse

mit
Plombiermöglichkeit
DIN 3133

ohne Schließhaken

Stck./Karte

1
1



1



| | | | | | | | | | | | | |
|------------|--|--------|-----|----|-----|----|------|---|-----|----|------------|------------|
| 001206105Z | | 160322 | 110 | 37 | Ø 4 | 30 | 2,52 | 3 | 4,5 | 25 | 000008025Z | 000009025Z |
| 001206130Z | | 160469 | 138 | 47 | Ø 5 | 38 | 4,94 | 3 | 4,5 | 25 | 000008030Z | 000009030Z |

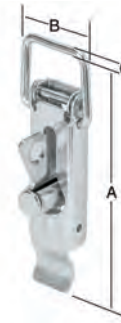

Spann- verschlüsse

mit Vorreiber
und Schlossöse
DIN 3133
mit
Plombiermöglichkeit

ohne Schließhaken

| | | | | | | | | | | | | |
|------------|---------------------|--------|-----|----|-----|----|------|---|-----|----|------------|------------|
| 001209105Z | | 160353 | 110 | 37 | Ø 4 | 24 | 2,16 | 3 | 4,0 | 25 | 000008025Z | 000009025Z |
| 001209130Z | | 160360 | 138 | 47 | Ø 5 | 35 | 4,55 | 3 | 4,5 | 25 | 000008030Z | 000009030Z |
| 011209105 | ROST FREI V2A | 180276 | 110 | 37 | Ø 4 | 24 | 1,72 | 3 | 4,0 | 20 | 010008025 | 010009025 |



Spann- verschlüsse

mit Schlossöse
DIN 3133
mit
Plombiermöglichkeit

ohne Schließhaken



| | | | | | | | | | | | | |
|------------|---------------------|--------|------------|----|----|----|------|---|-----|----|------------|------------|
| 001203000Z | | 160308 | 92/ 123 | 32 | Ø5 | 18 | 4,68 | 3 | 2,0 | 50 | 000008018Z | 000009018Z |
| 011203000 | ROST FREI V2A | 180375 | 92/ 123 | 32 | Ø5 | 18 | 1,68 | 3 | 2,0 | 20 | 010008018 | 010009018 |



Spann- verschlüsse

mit
Schraubverstellung

Verstellbereich
siehe Maß A

ohne Schließhaken

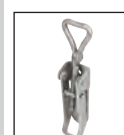

Spannverschlüsse/Schließhaken

Chest locks / Locking hooks
 Fermoirs de coffre à levier / Pattes pour
 fermoirs de coffre
 Cierres de caja / Ganchos de cierre de caja

Spannverschlüsse mit Schraubverstellung

Verstellbereich siehe Maß A

ohne Schließhaken



| Artikel-Nr. | Ausführung | GTIN 4003984 | Abmessungen mm | | | | ca. kg je VE | Schrauben | | verp. zu... Stck. | Passende Schließhaken DIN-Form G = Nr. 8 DIN-Form K = Nr. 9 G = gerade K = gekröpft | |
|-------------|------------|-----------------|-------------------|----|----|------|--------------------|-----------|------|-------------------------|---|------------|
| | | | A | B | C | Höhe | | Stck. | Ø mm | | | |
| 001205000Z | | 160452 | 125/ 145 | 47 | Ø7 | 20 | 4,68 | 2 | 6,0 | 25 | 000008030Z | 000009030Z |

Spannverschlüsse mit Schraubverstellung

Verstellbereich siehe Maß A

ohne Schließhaken



| | | | | | | | | | | | | |
|------------|--|--------|-------------|----|----|----|------|---|-----|----|------------|------------|
| 001207000Z | | 160438 | 153/ 170 | 47 | Ø7 | 23 | 5,56 | 2 | 6,0 | 25 | 000008030Z | 000009030Z |
|------------|--|--------|-------------|----|----|----|------|---|-----|----|------------|------------|

Spannverschlüsse DIN 3134 mit Schlossöse

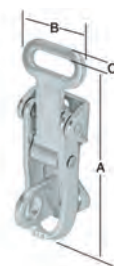

| | | | | | | | | | | | | |
|------------|--|--------|----|----|----|----|------|---|-----|----|--------------------------|------------|
| 001208070Z | | 160339 | 70 | 26 | Ø4 | 25 | 2,88 | 3 | 3,0 | 50 | 000008015Z 000008115Z | 000009015Z |
|------------|--|--------|----|----|----|----|------|---|-----|----|--------------------------|------------|

Spannverschlüsse DIN 3134

ohne Schließhaken



| | | | | | | | | | | | | |
|------------|--|--------|----|----|----|----|------|---|-----|----|--------------------------|------------|
| 001210070Z | | 160377 | 69 | 26 | Ø4 | 14 | 2,14 | 3 | 3,0 | 50 | 000008015Z 000008115Z | 000009015Z |
|------------|--|--------|----|----|----|----|------|---|-----|----|--------------------------|------------|

Schließhaken für Spannverschlüsse DIN 3133

gerade Form (Form G)

gekröpfte Form (Form K)

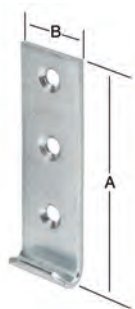

000008...

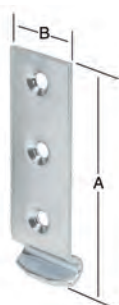

000009...

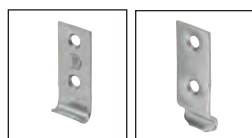

| Artikel-Nr. | Ausführung | GTIN 4003984 | Abmessungen mm | | | ca. kg je VE | Schrauben | | verp. zu... Stck. |
|-------------|------------|-----------------|-------------------|----|--------|--------------------|-----------|------|-------------------------|
| | | | A | B | Stärke | | Stck. | Ø mm | |
| 000008015Z | | 160025 | 17 | 15 | 2,0 | 0,26 | 2 | 3,5 | 50 |
| 000008018Z | | 160049 | 44 | 18 | 2,0 | 0,72 | 2 | 3,5 | 50 |
| 000008025Z | | 160056 | 82 | 25 | 2,5 | 1,07 | 3 | 4,5 | 25 |
| 000008030Z | | 160476 | 103 | 30 | 3,0 | 1,99 | 3 | 5,0 | 25 |
| 000008115Z | | 160063 | 44 | 15 | 2,0 | 0,60 | 2 | 3,5 | 50 |
| 010008018 | | 180016 | 44 | 18 | 2,0 | 0,26 | 2 | 3,5 | 20 |
| 010008025 | | 180412 | 82 | 25 | 2,0 | 0,70 | 3 | 4,5 | 20 |
| 010008115 | | 180023 | 44 | 15 | 2,0 | 0,23 | 2 | 3,5 | 20 |
| 000009015Z | | 160087 | 46 | 15 | 2,0 | 0,58 | 2 | 3,5 | 50 |
| 000009018Z | | 160100 | 48 | 18 | 2,0 | 0,70 | 2 | 3,5 | 50 |
| 000009025Z | | 160131 | 83 | 25 | 2,5 | 1,06 | 3 | 4,5 | 25 |
| 000009030Z | | 160155 | 108 | 30 | 3,0 | 1,96 | 3 | 5,0 | 25 |
| 010009015 | | 180030 | 46 | 15 | 2,0 | 0,22 | 2 | 3,5 | 20 |
| 010009018 | | 180047 | 48 | 18 | 2,0 | 0,27 | 2 | 3,5 | 20 |
| 010009025 | | 180405 | 83 | 25 | 2,0 | 0,68 | 3 | 4,5 | 20 |

Case hinges
 Pentures de coffre
 Bisagras para cajas

| Artikel-Nr. | Ausführung | GTIN 4003984 | Abmessungen mm | | | ca. kg je VE | Schrauben | | verp. zu... Stck. |
|-------------|---|-----------------|-------------------|----|--------|--------------------|-----------|------|-------------------------|
| | | | A | B | Stärke | | Stck. | Ø mm | |
| 000028120Z | | 080125 | 120 | 30 | 2 | 1,28 | 6 | 4,0 | 20 |
| 000028140Z | | 080132 | 140 | 35 | 2 | 1,79 | 8 | 4,0 | 20 |
| 000028160Z | | 080156 | 160 | 35 | 2 | 1,97 | 8 | 4,0 | 20 |
| 000028180Z | | 080163 | 180 | 35 | 2 | 2,24 | 8 | 4,0 | 20 |
| 000028200Z | | 080187 | 200 | 35 | 2 | 1,18 | 8 | 4,0 | 10 |
| 000028250Z | | 080194 | 250 | 38 | 2,5 | 1,99 | 10 | 5,0 | 10 |
| 000028300Z | | 080217 | 300 | 38 | 2,5 | 2,42 | 10 | 5,0 | 10 |
| 000028400Z | | 080231 | 400 | 40 | 3 | 4,00 | 10 | 5,0 | 10 |
| 000028500Z | | 080248 | 500 | 40 | 3 | 4,46 | 10 | 5,0 | 10 |
| 010028160 |  | 020619 | 160 | 35 | 2 | 0,99 | 8 | 4,0 | 10 |
| 010028200 | | 020626 | 200 | 35 | 2 | 1,21 | 8 | 4,0 | 10 |

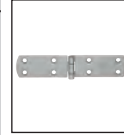
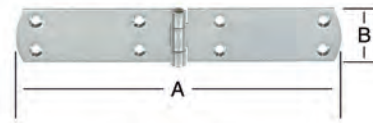

Gerollte starke französische Kistenbänder

mit vernietetem Messingstift, mit versenkten Schraublöchern

mit vernietetem Eisenstift

mit vernietetem Edelstahlstift



| | | | | | | | | | |
|------------|--|--------|-----|----|-----|------|---|-----|----|
| 000217170Z | | 080583 | 170 | 40 | 2,5 | 3,04 | 6 | 4,5 | 20 |
| 000217200Z | | 080699 | 200 | 40 | 3 | 4,23 | 6 | 5,0 | 20 |
| 000217170U | | 080576 | 170 | 40 | 2,5 | 0,15 | - | - | 1 |
| 000217200U | | 080606 | 200 | 40 | 3 | 0,21 | - | - | 1 |

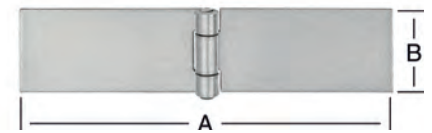
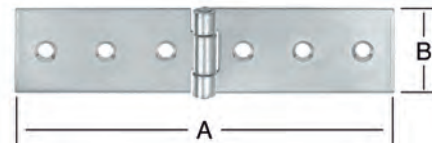

Gerollte starke Kistenbänder

mit vernietetem Eisenstift, mit versenkten Schraublöchern

ungebohrt, Eisen blank



| | | | | | | | | | |
|-----------|---|--------|-----|----|---|------|---|-----|---|
| 010096200 |  | 180092 | 200 | 35 | 2 | 0,64 | 4 | 5,0 | 5 |
|-----------|---|--------|-----|----|---|------|---|-----|---|

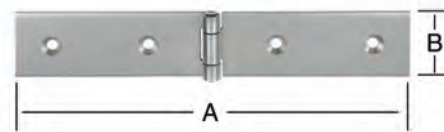

Gerollte starke Kistenbänder

mit vernietetem Edelstahlstift

| | | | | | | | | | |
|------------|--|--------|-----|----|-----|------|---|-----|----|
| 000044100Z | | 080316 | 193 | 29 | 1,5 | 1,11 | 6 | 3,0 | 20 |
| 000044125Z | | 080798 | 242 | 33 | 1,5 | 1,47 | 6 | 3,5 | 20 |
| 000044150Z | | 080323 | 292 | 33 | 1,5 | 1,80 | 8 | 3,5 | 20 |
| 000044200Z | | 080781 | 390 | 44 | 2,0 | 2,06 | 8 | 4,0 | 10 |

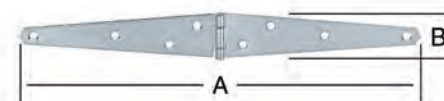

Gerollte Kistenbänder

mit vernietetem Eisenstift mit versenkten Schraublöchern



| | | | | | | | | | |
|------------|--|--------|-----|-----|-----|------|---|-----|----|
| 000042100Z | | 080262 | 97 | 60 | 1,5 | 0,54 | 6 | 3,0 | 10 |
| 000042125Z | | 080279 | 121 | 68 | 1,5 | 0,71 | 6 | 3,5 | 10 |
| 000042150Z | | 080286 | 146 | 68 | 1,5 | 0,80 | 7 | 3,5 | 10 |
| 000042200Z | | 080293 | 195 | 88 | 2,0 | 1,84 | 7 | 4,0 | 10 |
| 000042250Z | | 080774 | 245 | 100 | 2,0 | 2,36 | 8 | 4,0 | 10 |

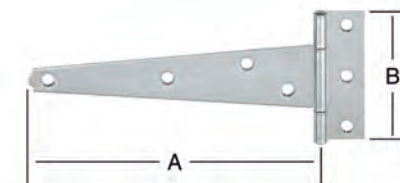

Gerollte T-Bänder

mit vernietetem Eisenstift und versenkten Schraublöchern





Edelstahlbänder

Stainless steel hinges
Pentures en acier inoxydable
Bisagras de acero inoxidable

Gerollte Edelstahl- bänder

mit vernietetem
Edelstahlstift
mit versenkten
Schraublöchern

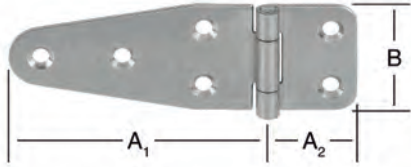

| Artikel-Nr. | Ausführung | GTIN 4003984 | Abmessungen mm | | | ca. kg je VE | Schrauben | | verp. zu... Stck. |
|-------------|------------|-----------------|-------------------|----|--------|--------------------|-----------|------|-------------------------|
| | | | A | B | Stärke | | Stck. | Ø mm | |
| 010043080 | V2A | 180054 | 80 28 | 37 | 1,5 | 0,95 | 6 | 4,0 | 20 |

Gerollte Edelstahl- bänder

mit vernietetem
Edelstahlstift
und versenkten
Schraublöchern

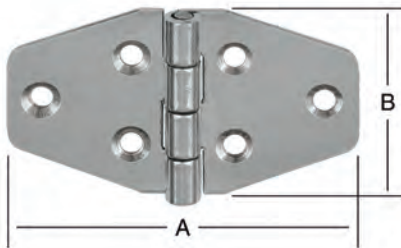

| | | | | | | | | | |
|-----------|-----|--------|----|----|-----|------|---|-----|----|
| 010046070 | V2A | 180542 | 70 | 40 | 1,5 | 0,72 | 6 | 3,0 | 20 |
|-----------|-----|--------|----|----|-----|------|---|-----|----|

Gerollte Edelstahl- bänder

mit vernieteten
Edelstahlstift
mit versenkten
Schraublöchern

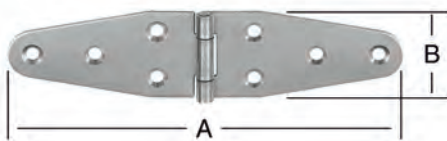

| | | | | | | | | | |
|-----------|-----|--------|-----|----|-----|------|---|-----|----|
| 010046160 | V2A | 180061 | 160 | 37 | 1,5 | 1,24 | 8 | 4,0 | 20 |
|-----------|-----|--------|-----|----|-----|------|---|-----|----|

Kistengriffe/Kistenecken

Case handles / Chest corners
Poignées de coffres / Coins de coffre
Asas para cajones / Cantoneras para cajas

| Artikel-Nr. | Ausführung | GTIN 4003984 | Abmessungen mm | | | ca. kg je VE | Schrauben | | verp. zu... Stck. |
|-------------|---|-----------------|-------------------|----|--------|--------------------|-----------|------|-------------------------|
| | | | A | B | Stärke | | Stck. | Ø mm | |
| 011330065 |  V2A | 180290 | 65 | 55 | 1,0 | 0,28 | 4 | 3,0 | 5 |

Edelstahl-Einlassgriffe

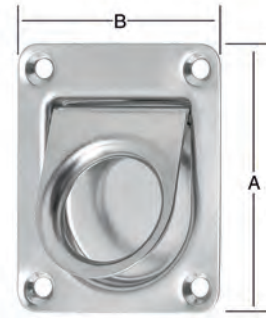

| | | | | | | | | | |
|------------|---|--------|-----|------|-----|------|---|-----|----|
| 000193110Z | | 170345 | 110 | 13,5 | 3,5 | 0,51 | 2 | 4,5 | 10 |
| 000193160W | | 170277 | 160 | 20 | 4,0 | 1,21 | 4 | 4,5 | 10 |
| 000193160S | | 180795 | 160 | 20 | 4,0 | 1,21 | 4 | 4,5 | 10 |
| 000193160Z | | 170284 | 160 | 20 | 4,0 | 1,21 | 4 | 4,5 | 10 |
| 000193200Z | | 170338 | 200 | 20 | 4,0 | 1,48 | 4 | 4,5 | 10 |
| 010193160 |  V2A | 180313 | 160 | 20 | 4,0 | 0,66 | 4 | 4,5 | 5 |
| 010193200 | | 180320 | 200 | 20 | 4,0 | 1,46 | 4 | 4,5 | 10 |

Handgriffe



| | | | | | | | | | |
|------------|---|--------|----|---|-----|------|---|-----|----|
| 000240028Z | | 160179 | 28 | - | 0,9 | 0,23 | 3 | 2,5 | 25 |
| 000240036Z | | 160193 | 36 | - | 1,0 | 0,56 | 3 | 3,0 | 25 |
| 000240045Z | | 160209 | 45 | - | 1,0 | 0,40 | 3 | 3,0 | 10 |
| 000240056Z | | 160216 | 56 | - | 0,9 | 1,74 | 3 | 4,0 | 25 |
| 010240036 |  V2A | 180238 | 36 | - | 1,0 | 0,35 | 3 | 3,0 | 20 |

Kistenecken (Schutzecken)

DIN 7469
hohe Form (A)



| | | | | | | | | | |
|------------|--|--------|----|----|-----|------|---|-----|----|
| 000241036Z | | 160421 | 36 | 10 | 1,0 | 0,32 | 4 | 3,0 | 25 |
|------------|--|--------|----|----|-----|------|---|-----|----|

Kistenecken (Schutzecken)

DIN 7469
flache Form (B)

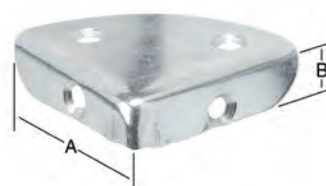



Kistengriffe

Case handles
Poignées de coffres
Asas para cajones

Einlass-Kistengriffe ähnlich DIN 3135

* mit abgerundeten Ecken

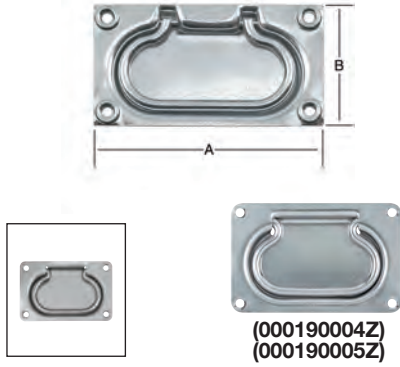

| Bestell-Nr. lose verpackt | Ausführung | GTIN 4003984 | Abmessungen mm | | | Griff Ø | ca. kg je VE | Schrauben | | verp. zu... Stck. |
|------------------------------|------------|-----------------|-------------------|-----|--------|------------|--------------------|-----------|------|-------------------------|
| | | | A | B | Stärke | | | Stck. | Ø mm | |
| 000190002Z | | 170031 | 100 | 80 | 1,75 | 7,0 | 1,42 | 4 | 4,5 | 10 |
| 000190003Z | | 170048 | 130 | 70 | 1,55 | 7,0 | 1,68 | 4 | 4,5 | 10 |
| 000190004Z* | | 170062 | 140 | 90 | 1,75 | 8,0 | 2,77 | 4 | 5,0 | 10 |
| 000190005Z* | | 170093 | 170 | 105 | 2,0 | 9,5 | 5,00 | 4 | 6,0 | 10 |
| 010190005* | | 180214 | 170 | 105 | 2,0 | 10 | 0,97 | 4 | 6,0 | 2 |

Kistengriffe DIN 3136



| | | | | | | | | | | |
|------------|--|--------|-----|-----|------|------|------|---|-----|----|
| 001328080Z | | 170192 | 80 | 70 | 1,25 | 6,5 | 1,03 | 4 | 4,5 | 10 |
| 001328100S | | 180788 | 100 | 80 | 1,5 | 7,5 | 1,70 | 4 | 4,5 | 10 |
| 001328100Z | | 170222 | 100 | 80 | 1,5 | 7,5 | 1,70 | 4 | 4,5 | 10 |
| 001328120Z | | 170246 | 120 | 95 | 1,5 | 7,5 | 2,06 | 4 | 5,0 | 10 |
| 001328135Z | | 170260 | 135 | 110 | 1,75 | 10,0 | 3,80 | 4 | 5,0 | 10 |
| 011328100 | | 180283 | 100 | 80 | 1,5 | 7,5 | 0,87 | 4 | 4,5 | 5 |

Kistengriffe

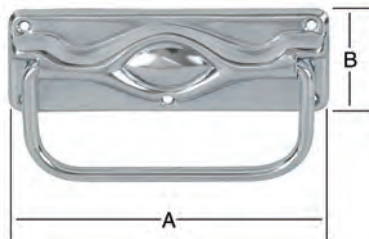

| | | | | | | | | | | |
|------------|--|--------|-----|----|---|-----|------|---|-----|----|
| 000192100Z | | 170109 | 100 | 35 | 1 | 5,0 | 0,64 | 5 | 2,4 | 10 |
|------------|--|--------|-----|----|---|-----|------|---|-----|----|

Kistengriffe mit loser Platte

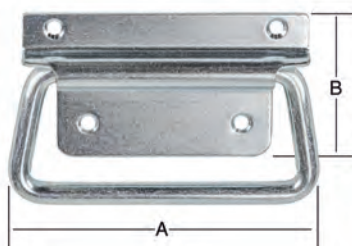

| | | | | | | | | | | |
|------------|--|--------|-----|----|-----|------|------|---|-----|----|
| 000197001Z | | 170376 | 105 | 45 | 1,5 | 7,5 | 1,20 | 4 | 3,5 | 10 |
| 000197002Z | | 170123 | 110 | 70 | 2 | 10,0 | 3,10 | 4 | 4,5 | 10 |

Kistengriffe

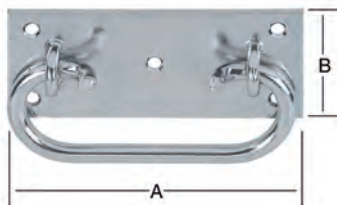

| | | | | | | | | | | |
|------------|--|--------|-----|----|------|-----|------|---|-----|----|
| 000198100Z | | 170161 | 108 | 45 | 1,75 | 7,0 | 1,53 | 5 | 3,5 | 10 |
| 000198120Z | | 170178 | 118 | 50 | 1,75 | 8,0 | 1,98 | 5 | 3,5 | 10 |

Vertreter / Ansprechpartner Inland:

Michael Wolfs
Nordstraße 32-34
52353 Düren
Tel.: 02421-7607843
Mobil-Tel.: 0173-5455549
m.wolfs@vormann.com

Edwin Benischke
Inh. Alexander Löb e.K
Grasiger Weg 11
90518 Altdorf
Tel.: 09187-959554
Fax: 09187-808296
Mobil-Tel.: 0172-9026677
edwin.benischke@onlinehome.de

Dietmar Sarnes
Aschhofen 16
83620 Feldkirchen-Westerham
Fax: 08063-2007128
Mobil-Tel.: 0163-8312020
dietmar.sarnes@web.de

Trudo Pfahl
Werksvertretung
Bachenauer Str. 15
74254 Offenau
Tel.: 07136-970380
Fax: 07136-970382
Mobil-Tel.: 0172-6688507
trudo.ofahl.wv@t-online.de

WMS
Jürgen Bürck
Nachtigallenweg 30
74855 Hassmersheim
Tel.: 06266-7775
Fax: 06266-7778
Mobil-Tel.: 0171-5321156
wms1jb@aol.com

Solibieda
Vertriebs- und Service GmbH
Höfkerstraße 27
44149 Dortmund
Tel.: 0231-9172230
Fax: 0231-91722320
solibieda@solibieda.de

Jörg Lang
Zur Heide 19
16348 Wandlitz
Tel.: 0231-9172230
Fax: 03222-1565100
Mobil-Tel.: 0171-5154962
joerg.lang@solibieda.de

Nur Fachhandel

 Rosendahl & Koppel
Inh.: M. Petersen
Bahnhofstr. 15
21465 Reinbek bei Hamburg
Tel.: 040/234147
Fax: 040/233691
Mobil-Tel.: 0171-8063050
mark.petersen@roko-petersen.de

Karl Kregeler
Werksvertretungen
Herrendienstweg 71
32120 Hiddenhausen
Tel.: 05221-96900
Fax: 05221-969030
Mobil-Tel.: 0171-8547763
info@kregeler-
werksvertretungen.de

Rufen Sie uns an und wir nennen Ihnen Ihren zuständigen Außendienstmitarbeiter unter 0 23 33/978-0

Vertreter / Ansprechpartner Ausland:

Afrika
August Vormann SA (PTY) LTD.
P.O. Box 4545
ZA 6539 George East
Tel.: 0027-44-8781441
Fax: 0027-44-8781408
info@vormann.co.za

Belgien
Husquin & Co SA
Ikaroslaan 69
B-1930 Nossegem-Zaventem
Tel.: 0032-2-2620900
Fax: 0032-2-2685241
info@husquin.com

Dänemark
Roliba A/S
Hvidkaervej 52
DK-5250 Odense
Tel.: 0045-65930357
Fax: 0045-65932757
e-mail: post@roliba.dk

Estland
HeWood OÜ
Haapsalu mnt 21
EE-76605 Keila, Harjumaa
Tel.: 00372-53595155
tellimine@hewood.ee

Frankreich
Christophe Isoux
ADF DIFFUSION
1, rue de la Jaunaie
F-35500 Vitre
Tel.: 0033-256538305
Mobil-Tel.: 0610137139
Fax: 0033-253596055
Email: adfisoux@aol.com

Griechenland
Voyatzoglou Systems S.A.
12 Km. Nat. Road Athens-Lamina
GR-14451 Metamorfoosi-Athens
Tel.: 0030-2102888600
Fax: 0030-2102888699
info@voyatzoglou.gr
www.voyatzoglou.gr
www.visitgreece.gr

Lettland
SB & Partneri
Renčenu iela 21 2.St.
LV-1073, Rīga
Tel.: 00371-67113070
info@sbunpartneri.lv

Niederlande
Ruro Gereedsschappen B.V.
Vestingdok 4
NL-3433 KR Nieuwegein
Tel.: 0031-30 608 42 42
Fax: 0031-30 608 17 69
info@ruro.nl
www.ruro.nl

Österreich
Christian Altenhofer
Kokoschka Straße 31
A-4020 Linz
Tel.: 0043-6642147423
ch.altenhofer@liwest.at

Pohl & Co GmbH & Co. KG
Metallwarenerzeugung
Zeller Str. 3
A-4600 Wels
Tel.: 0043-724246673
Fax: 0043-724242160
office@pohl.co.at

Polen
Aspeo sp.z o.o.
ul. Dąbrowskiego 97C/5
PL - 60-574 Poznań
Tel.: 0048-61-6463252
Fax: 0048-61-6463258
info@aspeo.pl
www.aspeo.pl/pl

Rumänien
EuroNarcis
Str. Muresului nr. 1A
RO-547526 Nazna, jud. Mures
Tel.: 0040-265320013
Fax: 0040-265320083
office@euronarcis.ro

Russland
OOO "GTL" RUSSIA
Yl.3-Sovetskay, de 11, lit A, pom 1H
RUS-193015 St. Petersburg
Tel.: 007-812-4599847
Fax: 007-812-4599848
manager.one@gtl.spb.ru

Schweiz
SFS unimarket AG
Rosenbergsaustrasse 4
CH-9435 Heerbrugg
Tel.: 0041-717275151
Fax: 0041-717275499
info@sfs.ch

Etter + Co. AG
Espenmatt 1
CH-9220 Bischofszell
Tel.: 0041-714242121
Fax: 0041-714242131
mail: info@webi.ch

Slowenien
Zelezna Hudovertnik d.o.o.
Partizanska c. 2
SLO-3320 Velenje
Tel.: 00386-3898 23 50
Fax: 00386-3898 23 60
info@zelezna.si

Tschechien
Dastech s.r.o.
Delnická 57
CZ-41712 Probošov
Tel./Fax: 00420-417 532 894
Mobil-Tel.: 00420-603 170 967
dastech@seznam.cz
www.dastech.cz

Jiří Dušek
Porická 716/8
CZ-198 00 Praha 9
Mobil-Tel.: 00420-603 439 308
jirha@seznam.cz

Ungarn
Tamas Györe
Cibkháza u. 78/1
HU-1162 Budapest
Tel.: 0036-704288228
gyore.tamas@gmail.com

VORMANN
SCHARNIERE · BESCHLÄGE



August Vormann GmbH & Co. KG
Postfach 15 52
58244 Ennepetal

Heilenbecker Str. 191 -205
58256 Ennepetal
Deutschland / Germany

Telefon : ++49 (0) 2333 / 978 - 0
Telefax : ++49 (0) 2333 / 978 - 241599
www.vormann.com
E-Mail: info@vormann.com



Art-Nr. 089500052AV

