

BESSEY Span- en kniptechniek

Lijst van accessoires en reserveonderdelen 2023/2024

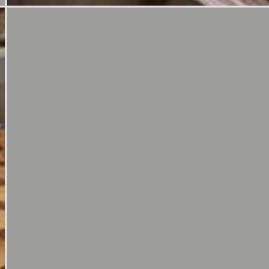

Gewoon beter.

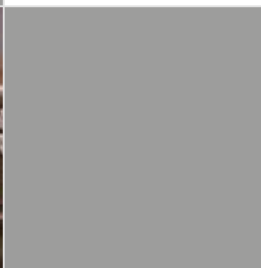
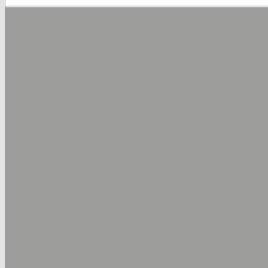

Lijst van accessoires en reserveonderdelen 2023/2024

4-7 Lijmtangen met gegoten beugels



TG / TPN
TGK / TKPN
TGNT

8-11 Geheel stalen lijmtangen



GZ / GS
G...Z
GU25-12-6ZK
GMZ

12-13 Snelspanklemmen



GH / GSH
GHS / G...H

14-15 Constructieklemmen



SLM / SGM / SGL
SG...M / STBM
STBS / STBVC
SGU / STBU
GSL / GSM

16 Variable schroefklemmen



SLV / GSV

17 Constructieklemmen met achterspindel



GRA...12

17 Snelspanner



STC-VH / STC-HH
STC-HV / STC-HA
STC-IHH / STC-IHA
TW..A-STC
TW..VAD / TWVAD

18-20 Spanelementen



TWV / TW
TWM28
TW28GRS
WNS-SET-MFT

21 Machinentafelspanners



BAS
BSN
SGHS

22 Corpuslijmtangen



KRE / KREV
KR / KRV / K

23 Corpusspanner



KS

23 Vlakspanner



FK

23 Aandrijfklem GearKlamp



GK

24 Eénhandsklemmen



EHZ / EZS / EZ

25 Spantenlijmtang

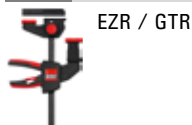
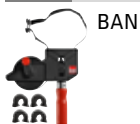
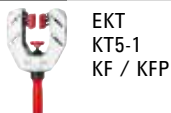
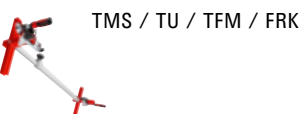

SPZ

26 Griptangen**26 KliKlamp****27 Schroefspanner en hoekspanner****27 Tafelklem****28 Bandspanner****29 Kantenlijmtangen en Platendrager****29 Platenspanner****30-32 Deur- en venster-
montage-gereedschap****TAN / TB / TL****33 Plafond- en montage-
steun****34 Blikscharen met
hefboomoverbrenging****35 Standaard
blikscharen****36 Knabbelscharen en
knipmessen**

Technische wijzigingen voorbehouden. Wij kunnen geen verantwoordelijkheid aanvaarden voor eventuele drukfouten.

Lijst van accessoires en reserveonderdelen 2023/2024



Lijmtangen met gegoten beugels

geschikt voor serie TG en TPN

	Ondergedeelte compleet met 2-componenten handgreep		2-componenten handgreep incl. verwisselbare drukplaat met beschermkap			Ondergedeelte compleet met houten handgreep		Houten handgreep incl. verwisselbare drukplaat met beschermkap		
	Span-diepte mm	voor profiel mm	Lengte x Ø mm	Kop Ø mm	Trapezi-umdraad mm	Span-diepte mm	voor profiel mm	Lengte x Ø mm	Kop Ø mm	Trapezi-umdraad mm
TG10 / TG...B5										
Bestelnr.	-		-			-		-		
TG12 / TG...B6										
Bestelnr.	-		-			-		-		
TG 16 TG...B8 TPN 16 TPN...B8			110 x 30	10	14 x 4					
Bestelnr.	-		3101179			-		-		
TG 20 TG...S10 TPN 20 TPN...S10			110 x 30	12	16 x 4	100	27 x 7	112 x 30	12	16 x 4
Bestelnr.	-		3101182			3101413		3101386		
TG 25 TG...S12 TPN 25 TPN...S12	120	29 x 9	130 x 34	12	16 x 4	120	29 x 9	125 x 32	12	16 x 4
Bestelnr.	3101832		3101186			3101414		3101389		
TG 30 TG...S14 TPN 30 TPN...S14	140	32 x 10	130 x 34	13	18 x 5	140	32 x 10	140 x 35	13	18 x 5
Bestelnr.	3101833		3101187			3101415		3101390		
TG 40 TG...S17	175	32 x 10	130 x 34	13	18 x 5	175	32 x 10	140 x 35	13	18 x 5
Bestelnr.	3101834		3101187			3101416		3101390		
TPN 40 TPN...S17	175	32 x 10	130 x 34	13	18 x 5	175	32 x 10	140 x 35	13	18 x 5
Bestelnr.	3101834		3101187			3101416		3101390		

Lijmtangen met gegoten beugels

geschikt voor serie TG en TPN

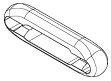
	Drukplaat met beschermkap uitwisselbaar van grootte 16	Beschermkap voor bovenste en onderste deel		Beschermkapstrook SKS	Knevelopzetstuk KA
					
	4 paar	10 paar		2 stuks	2 stuks
	Ø mm	voor Ø mm	voor breedte onderste deel mm		enkel voor knevelvarianten passend
TG10 / TG...B5	22	22	17		
Bestelnr.	3101339	3101391		-	-
TG12 / TG...B6	22	22	19		
Bestelnr.	3101339	3101392		-	-
TG 16 TG...B8 TPN 16 TPN...B8	25,5	25,5	23		
Bestelnr.	3101180	3101393		-	-
TG 20 TG...S10 TPN 20 TPN...S10	32	32	28		
Bestelnr.	3101183	3101394		-	3101194*
TG 25 TG...S12 TPN 25 TPN...S12	32	32	30		
Bestelnr.	3101183	3101395		-	3101194*
TG 30 TG...S14 TPN 30 TPN...S14	38,5	38,5	32		
Bestelnr.	3101188	3101396		-	3101194*
TG 40 TG...S17	38,5	38,5	32		
Bestelnr.	3101188	3101396		-	3101194*
TPN 40 TPN...S17	38,5				
Bestelnr.	3101188	-		SKS20/40	3101194*

*Levering zolang de voorraad strekt

Lijst van accessoires en reserveonderdelen 2023/2024

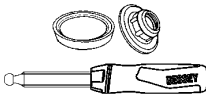
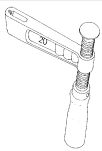
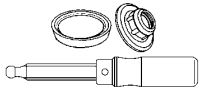

Lijmtangen met gegoten beugels

geschikt voor serie TGK en TKPN

	Ondergedeelte compleet met 2-componenten handgreep		2-componenten handgreep incl. verwisselbare drukplaat met beschermkap			Ondergedeelte compleet met houten handgreep		Handgreep incl. verwisselbare drukplaat met beschermkap		
	Span-diepte mm	voor profiel mm	Lengte x Ø mm	Kop Ø mm	Trapezi-umdraad mm	Span-diepte mm	voor profiel mm	Lengte x Ø mm	Kop Ø mm	Trapezi-umdraad mm
										
TGK TKPN	120	35 x 11	130 x 34	13	18 x 5	120	35 x 11	140 x 35	13	18 x 5
Bestelnr.	3101838		3101187			3101417		3101390		

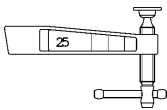

Lijmtangen met gegoten beugels

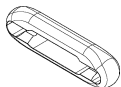
geschikt voor serie TGK en TKPN

	Knevelgreep		Drukplaat met beschermkap	Beschermkapstrook SKS		Knevelopzetstuk KA
	Span-diepte mm	voor profiel mm	Ø mm	voor Ø mm	voor breedte onderste deel mm	enkel voor knevelvarianten passend
			 4 paar	 2 stuks		 2 stuks
TGK TKPN			38,5	25,5	23	
Bestelnr.	-		3101188	SKS20/40		3101194*
TGK-K	120	35 x 11	38,5	25,5	23	
Bestelnr.	3101418		3101188	SKS20/40		3101194*

Lijmtangen met gegoten beugels

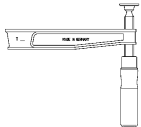
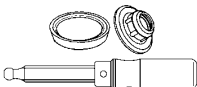
geschikt voor serie TGN

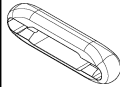
	Ondergedeelte compleet met handgreep		Houten handgreep incl. verwisselbare drukplaat met beschermkap			Drukplaat met beschermkap	Knevel-opzetstuk KA
							
						4 paar	2 stuks
	Spandiepte mm	voor profiel mm	Lengte x Ø mm	Kop Ø mm	Trapeziumdraad mm	Ø mm	enkel voor knevelvarianten passend
TGN...T20	200	35 x 11	140 x 35	13	18 x 5	38,5	
Bestelnr.	3101419		3101390			3101188	3101194*
TGN...T25	250	40 x 11	140 x 35	13	18 x 5	38,5	
Bestelnr.	3101420		3101390			3101188	3101194*
TGN...T30	300	45 x 12	140 x 35	13	18 x 5	38,5	
Bestelnr.	3101421		3101390			3101188	3101194*
TGN...T40			140 x 35	13	18 x 5	38,5	
Bestelnr.	-		3101390			3101188	3101194*
TGN...T50			140 x 35	13	18 x 5	38,5	
Bestelnr.	-		3101390			3101188	3101194*

Lijst van accessoires en reserveonderdelen 2023/2024

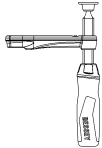
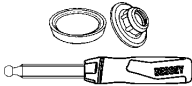
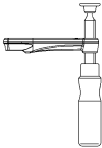
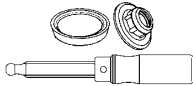

Geheel stalen lijmtangen – **nieuwe versie vanaf 01.07.09**

geschikt voor serie GZ

Glijbeugel compleet 2-componenten handgreep		2-componenten handgreep incl. verwisselbare drukplaat met beschermkap			Glijbeugel compleet met houten handgreep		Houten handgreep incl. verwisselbare drukplaat met beschermkap				
											
Span- diepte mm	voor profiel mm	Lengte x Ø mm	Kop Ø mm	Trapezi- umdraad mm	Span- diepte mm	voor profiel mm	Lengte x Ø mm	Kop Ø mm	Trapezi- umdraad mm		
GZ 10 / GZ 12											
Bestelnr.		–			–		–				
GZ 16		110 x 30			14 x 4						
Bestelnr.		3101179			–		–				
GZ 20 GZ...-10		100	22 x 8,5	110 x 30	12	16 x 4	100	22 x 8,5	112 x 30	12	16 x 4
Bestelnr.		3101955		3101182			3101516		3101386		
GZ 25 GZ...-12		120	24 x 9,5	130 x 34	12	16 x 4	120	24 x 9,5	125 x 32	12	16 x 4
Bestelnr.		3101835		3101186			3101517		3101389		
GZ 30		140	28 x 11	130 x 34	13	18 x 5	140	28 x 11	140 x 35	13	18 x 5
Bestelnr.		3101836		3101187			3101518		3101390		
GZ 40 - GZ 125		120	28 x 11	130 x 34	13	18 x 5	120	28 x 11	140 x 35	13	18 x 5
Bestelnr.		3101837		3101187			3101519		3101390		

Geheel stalen lijmtangen – nieuwe versie vanaf 01.07.09

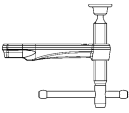
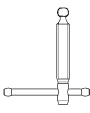
geschikt voor serie GZ

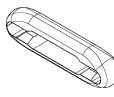
Glijbeugel compleet met knevelgreep		Knevelgreep	Opklapbare 2-componenten handgreep incl. verwisselbare drukplaat met beschermkap			Drukplaat met beschermkap uitwisselbaar van grootte 16	Knevelopzetstuk KA	
								
Span- diepte mm	voor profiel mm	Trapeziumdraad mm	Lengte x Ø mm	Kop Ø mm	Trapezi- umdraad mm	Ø mm	enkel voor knevelvarianten passend	
GZ 10 / GZ 12						22		
Bestelnr.		–	–	–	–	3101339	–	
GZ 16			14 x 4			25,5		
Bestelnr.		–	3101795	–	–	3101180	–	
GZ 20 GZ...-10		100	22 x 8,5	16 x 4		32		
Bestelnr.		3101441		3101796	–	3101183	3101194*	
GZ 25 GZ...-12		120	24 x 9,5	16 x 4	125 x 35	12	16 x 4	
Bestelnr.		3101444		3101796	3101958		3101183	3101194*
GZ 30		140	28 x 11	18 x 5		38,5		
Bestelnr.		3101447		3101797	–	3101188	3101194*	
GZ 40 - GZ 125		120	28 x 11	18 x 5		38,5		
Bestelnr.		3101450		3101797	–	3101188	3101194*	

Lijst van accessoires en reserveonderdelen 2023/2024

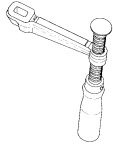
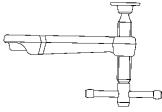
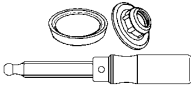
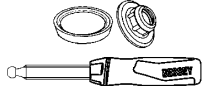

OMEGA-Geheel stalen lijmtangen en Geheel stalen lijmtangen classiX alsmede Geheel stalen lijmtangen – oude versie tot 30.06.09

geschikt voor serie GMZ, G...Z, GS

	Glijbeugel compleet met houten handgreep		Glijbeugel compleet met knevelgreep		Houten handgreep incl. verwisselbare drukplaat met beschermkap			2-componenten handgreep incl. verwisselbare drukplaat met beschermkap		
	Span- diepte mm	voor profiel mm	Span- diepte mm	voor profiel mm	Lengte x Ø mm	Kop Ø mm	Trapezi- umdraad mm	Lengte x Ø mm	Kop Ø mm	Trapezi- umdraad mm
G10Z / G12Z GS10 / GS12										
Bestelnr.	–		–		–			–		
G16Z / GS16								110 x 30	10	14 x 4
Bestelnr.	–		–		–			3101179		
G20Z/G...-S10Z GS20 GM 20Z GM...S10Z	100	19,5 x 9,5	100	19,5 x 9,5	112 x 30	12	16 x 4	110 x 30	12	16 x 4
Bestelnr.	3101422		3101800		3101386			3101182		
G25Z/G...-S12Z GS25 GM 25Z GM...-S12Z GU25-12-6ZK	120	22 x 10,5	120	22 x 10,5	125 x 32	12	16 x 4	130 x 34	12	16 x 4
Bestelnr.	3101423		3101801		3101389			3101186		
G30Z / GS30 GM30Z	140	25 x 12	140	25 x 12	140 x 35	13	18 x 5	130 x 34	13	18 x 5
Bestelnr.	3101424		3101802		3101390			3101187		
G40Z-G60Z GS40-GS60 GM40Z-GM60Z	120	25 x 12	120	25 x 12	140 x 35	13	18 x 5	130 x 34	13	18 x 5
Bestelnr.	3101425		3101803		3101390			3101187		
G80Z-G125Z GS80-GS100 GM80Z-GM125Z	120	27 x 13	120	27 x 13	140 x 35	13	18 x 5	130 x 34	13	18 x 5
Bestelnr.	3101426		3101804		3101390			3101187		

OMEGA-Lijmtangen en Geheel stalen lijmtangen classiX alsmede Geheel stalen lijmtangen – oude versie tot 30.06.09

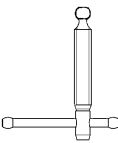
geschikt voor serie GMZ, G...Z, GS

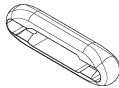
	Knevelgreep	Drukplaat met beschermkap uitwisselbaar van grootte 16	Knevelopzetstuk KA
		 4 paar	 2 stuks
	Trapeziumdraad mm	Ø mm	enkel voor knevelvarianten passend
G10Z / G12Z GS10 / GS12		22	
Bestelnr.	–	3101339	–
G16Z / GS16	14 x 4	25,5	
Bestelnr.	3101795	3101180	–
G20Z/G...-S10Z GS20 GM 20Z GM...S10Z	16 x 4	32	
Bestelnr.	3101796	3101183	3101194*
G25Z/G...-S12Z GS25 GM 25Z GM...-S12Z GU25-12-6ZK	16 x 4	32	
Bestelnr.	3101796	3101183	3101194*
G30Z / GS30 GM30Z	18 x 5	38,5	
Bestelnr.	3101797	3101188	3101194*
G40Z-G60Z GS40-GS60 GM40Z-GM60Z	18 x 5	38,5	
Bestelnr.	3101797	3101188	3101194*
G80Z-G125Z GS80-GS100 GM80Z-GM125Z	18 x 5	38,5	
Bestelnr.	3101797	3101188	3101194*

*Levering zolang de voorraad strekt

Lijst van accessoires en reserveonderdelen 2023/2024

Snelspanklemmen – GH – **nieuwe versie vanaf 01.03.10**

geschikt voor serie GH

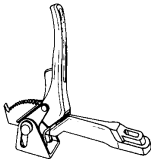
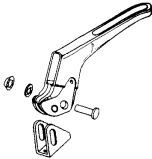
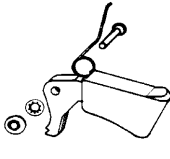
	Glijbeugel compleet		Hefboom met drukplaat compleet	Vergrendelpal compleet
				 2 stuks
	Spandiepte mm	voor profiel mm	Bout-Ø x l mm	Bout-Ø x l mm
GH 12 GH 16				5h11 x 21
Bestelnr.	–		–	3101399
GH 20 GH...-10	100	22 x 8,5	10 x 33,5	5h11 x 23
Bestelnr.	3101522		3101397	3101400
GH 25 GH...-12	120	24,5 x 9,5	10 x 33,5	5h11 x 23
Bestelnr.	3101523		3101397	3101400
GH 30	140	28 x 11	12 x 38	5h11 x 26
Bestelnr.	3101524		3101398	3101401
GH 40 - GH 100	120	28 x 11	12 x 38	5h11 x 26
Bestelnr.	3101525		3101398	3101401

Snelspanklemmen classiX – GSH alsmede snelspanklemmen – GH – oude versie tot 28.02.10

geschikt voor serie G...H, GSH

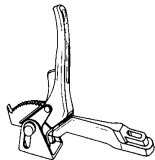
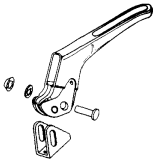
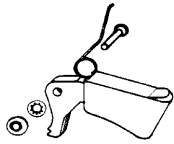

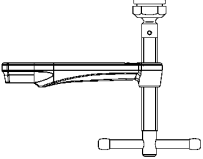
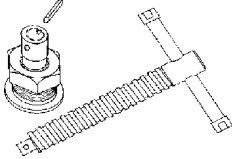
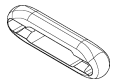

	Glijbeugel compleet		Hefboom met drukplaat compleet	Vergrendelpaal compleet
				 2 stuks
	Spandiepte mm	voor profiel mm	Bout-Ø x l mm	Bout-Ø x l mm
G12H / G...S6H G16H / G...S8H GSH12 - GSH16				5h11 x 21
Bestelnr.	-		-	3101399
G20H / G...S10H GSH20	100	19,5 x 9,5	10 x 33,5	5h11 x 23
Bestelnr.	3101333		3101397	3101400
G25H / G...S12H GSH25 GU-H	120	22 x 10,5	10 x 33,5	5h11 x 23
Bestelnr.	3101334		3101397	3101400
G30H GSH30	140	25 x 12	12 x 38	5h11 x 26
Bestelnr.	3101335		3101398	3101401
G40H - G60H GSH40 - GSH60	120	25 x 12	12 x 38	5h11 x 26
Bestelnr.	3101336		3101398	3101401
G80H - G100H	120	27 x 13	12 x 38	5h11 x 26
Bestelnr.	3101337		3101398	3101401

Lijst van accessoires en reserveonderdelen 2023/2024

Hoogwaardige constructieklemmen – SLM en SGM – **nieuwe versie vanaf 01.07.08**

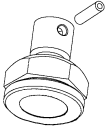
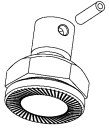
	Glijbeugel compleet		Combiset (Spindel + speciale drukplaat + veerpin)		Knevelopzetstuk KA
					
	Spandiepte mm	voor profiel mm	Trapeziumdraad mm	Knevel Ø x Lengte mm	2 stuks
SLM	120	28 x 11	18 x 5	10 x 120	
Bestelnr.	3101521		3100398		3101194*
SGM	140	34 x 13	20 x 5	11 x 120	
Bestelnr.	3101407		3100399		–

Hoogwaardige constructieklemmen – SLM/SGM/STBM/STBVC/SGU/STBU/STBS

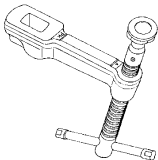
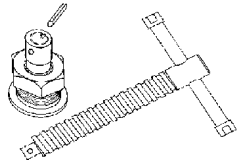
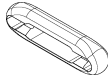

	Speciale drukplaat standaard		Speciale drukplaat gekarteld		Speciale drukplaat met prisma		Schroef- draadbus met borgring	Wig STBS
								
	Spindelgat mm	Veerpen mm	Spindelgat mm	Veerpen mm	Spindelgat mm	Veerpen mm	Schroef- draad	2 stuks
SLM / SGM STBM / STBVC SGU	12	5 x 20	12	5 x 20	12	5 x 20		
Bestelnr.	3100736		3101192		3101193		–	–
STBU	12	5 x 20	12	5 x 20	12	5 x 20		
Bestelnr.	3100737		3101192		3101193		–	–
STBS	12	5 x 20					M 24	
Bestelnr.	3100737		–		–		3100579	3101788

Hoogwaardige constructieklemmen – STBVC/STB/STBS
Hoogwaardige constructieklemmen classiX – GSL en GSM
alsmede Hoogwaardige constructieklemmen – SGL en SGM – oude versie tot 30.06.08

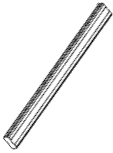
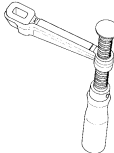
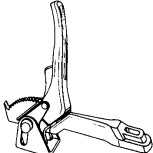
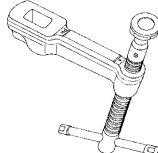

	Glijbeugel compleet		Combiset (Spindel + speciale drukplaat + veerpin)		Knevelopzetstuk KA
	Spandiepte mm	voor profiel mm	Trapeziumdraad mm	Knevel Ø x Lengte mm	
					
					2 stuks
SGL...M / GSL	120	27 x 13	18 x 5	10 x 120	
Bestelnr.	3101338		3100398		3101194*
SG...M	120	30 x 15	20 x 5	11 x 120	
Bestelnr.	3101329		3100399		–
SG30M / GSM / SGU	140	30 x 15	20 x 5	11 x 120	
Bestelnr.	3101330		3100399		–
SG..T20M	200	30 x 15	20 x 5	11 x 120	
Bestelnr.	3101331		3100399		–
STB...M/STBU	175	40 x 20	22 x 5	11 x 180	
Bestelnr.	3101332		3100400		–
STBS	200	50 x 25	M24	18 x 345	
Bestelnr.	3101798		3100401		–
STBVC	100	40 x 20	22 x 5	11 x 180	
Bestelnr.	3101882		3100400		–

Lijst van accessoires en reserveonderdelen 2023/2024

Variabele hoogwaardige constructieklemmen SLV, GSV

	Profiel met 2 eindbeveiliging		Glijbeugel compleet met houten handgreep		Glijbeugel compleet met hefboomgreep		Glijbeugel compleet met knevelgreep		Knevel-opzetstuk KA
									
	Spandiepte mm	Profiel mm	Spandiepte mm	voor profiel mm	Spandiepte mm	voor profiel mm	Spandiepte mm	voor profiel mm	enkel voor knevelvarianten passend
SLV	1000	27 x 13	120	27 x 13	120	27 x 13	120	27 x 13	2 stuks
Bestelnr.	3101731		3101426		3101337		3101338		3101194*
SLV	1500	27 x 13	120	27 x 13	120	27 x 13	120	27 x 13	
Bestelnr.	3101732		3101426		3101337		3101338		3101194*
SLV	2000	27 x 13	120	27 x 13	120	27 x 13	120	27 x 13	
Bestelnr.	3101733		3101426		3101337		3101338		3101194*

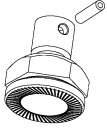
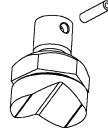
GSV	3000	30 x 15					120	30 x 15	
Bestelnr.	3101612		-		-		3101329		-
GSV	3000	30 x 15					140	30 x 15	
Bestelnr.	3101612		-		-		3101330		-
GSV	3000	30 x 15					200	30 x 15	
Bestelnr.	3101612		-		-		3101331		

	Speciale drukplaat standaard		Speciale drukplaat gekarteld		Speciale drukplaat met prisma		Eind-beveiliging
							
	Spindelgat mm	Veerpen mm	Spindelgat mm	Veerpen mm	Spindelgat mm	Veerpen mm	2 paar
SLV / GSV	12	5 x 20	12	5 x 20	12	5 x 20	
Bestelnr.	3100736		3101192		3101193		3101782

Constructieklemmen met achterspindel – nieuwe versie vanaf 01.04.12

	Grijparm compleet		Spindel compleet	
	Spandiepte mm	voor profiel mm	Trapeziumdraad mm	Knevel Ø x l mm
GRA...12	120	28 x 11	18 x 5	8 x 110
Bestelnr.	3101590		3100562	

Variabele snelspanner STC

	Spindelset compleet	Voor multifunctionele tafel Adapter	Voor lastafels		Verlengstuk	
			Snelspanner-adapter		Gat Ø	Aanpas- singsbereik
STC-VH20 / STC-HH20 STC-IHH 15		 1 cilinderbout DIN 912 M 8 x 35 1 steekbout D20 x 17 1 kartelmoer M8				
Bestelnr.	3101627	–	Gat Ø 16 TW16A-STC	Gat Ø 28 TW28A-STC		–
STC-HV20 / STC-HA20 STC-IHA 15						
Bestelnr.	3101627	–	–	–		–
STC-VH50 / STC-HH 50 STC-IHH 25						
Bestelnr.	3101589	STC-SET-T20	16 TW16A-STC	28 TW28A-STC		–
STC-HH 70						
Bestelnr.	3101588	STC-SET-T20	16 TW16A-STC	28 TW28A-STC		–
TW16A-STC TW16VAD / TWVAD					16	15-200
Bestelnr.	–	–	–	–	TW16X	
TW28A-STC TW28VAD / TWVAD					28	15-300
Bestelnr.	–	–	–	–	TW28X	

Lijst van accessoires en reserveonderdelen 2023/2024

Spanelement met variabele spandiepte TWV

	Profiel		Kruishouder compleet	Glijbeugel compleet met 2-componenten handgreep		Glijbeugel compleet met knevelgreep		Glijbeugel compleet met hefboomgreep		Werkbank-adapter
	Span-diepte mm	Profiel mm	voor profiel mm	Span-diepte mm	voor profiel mm	Span-diepte mm	voor profiel mm	Span-diepte mm	voor profiel mm	geschikt voor
TWV16	200	22 x 8,5	22 x 8,5	30-150	22 x 8,5	30-150	22 x 8,5	60-150	22 x 8,5	19 mm/3/4"
Bestelnr.	3101740		3101744	3101741		3101742		3101743		TW16AW19
TWV16	200	22 x 8,5	22 x 8,5	30-150	22 x 8,5	30-150	22 x 8,5	60-150	22 x 8,5	20 mm/13/16"
Bestelnr.	3101740		3101744	3101741		3101742		3101743		TW16AW20
TWV16	200	22 x 8,5	22 x 8,5	30-150	22 x 8,5	30-150	22 x 8,5	60-150	22 x 8,5	25,4 mm/1"
Bestelnr.	3101740		3101744	3101741		3101742		3101743		TW16AW25"
TWV16	200	22 x 8,5	22 x 8,5	30-150	22 x 8,5	30-150	22 x 8,5	60-150	22 x 8,5	30 mm/1 3/16"
Bestelnr.	3101740		3101744	3101741		3101742		3101743		TW16AW30
TWV28	300	28 x 11	28 x 11	40-175	28 x 11	40-175	28 x 11	110-175	28 x 11	—
Bestelnr.	3101706		3101710	3101707		3101708		3101709		—

Horizontale spanner voor multifunctionele tafel WNS-SET-MFT



Bankhaken voor multifunctionele tafel	
 <p>4 x bankhaken 4 x kartelmoer</p>	
Bout-Ø mm	
WNS-SET-MFT	20
Bestelnr.	BH-MFT

Spanelement met een vaste spandiepte TW

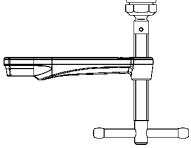

	Profiel		Glijbeugel compleet met houten handgreep		Glijbeugel compleet met knevelgreep		Glijbeugel compleet met hefboomgreep		Werkbank-adapter
	Spandiepte mm	Profiel mm	Spandiepte mm	voor profiel mm	Spandiepte mm	voor profiel mm	Spandiepte mm	voor profiel mm	geschikt voor
TW16	200	22 x 8,5	100	22 x 8,5	100	22 x 8,5	100	22 x 8,5	19 mm/3/4"
Bestelnr.	3101740		3101516		3101441		3101522		TW16AW19
TW16	200	22 x 8,5	100	22 x 8,5	100	22 x 8,5	100	22 x 8,5	20 mm/13/16"
Bestelnr.	3101740		3101516		3101441		3101522		TW16AW20
TW16	200	22 x 8,5	100	22 x 8,5	100	22 x 8,5	100	22 x 8,5	25,4 mm/1"
Bestelnr.	3101740		3101516		3101441		3101522		TW16AW25*
TW16	200	22 x 8,5	100	22 x 8,5	100	22 x 8,5	100	22 x 8,5	30 mm/1 3/16"
Bestelnr.	3101740		3101516		3101441		3101522		TW16AW30
TW28	300	28 x 11	120	28 x 11	120	28 x 11	120	28 x 11	–
Bestelnr.	3101706		3101519		3101450		3101525		–
TW28	300	28 x 11	140	28 x 11	140	28 x 11	140	28 x 11	–
Bestelnr.	3101706		3101518		3101447		3101524		–

Lijst van accessoires en reserveonderdelen 2023/2024



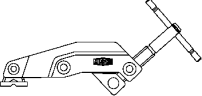

Spanelement met speciale drukplaat TWM28

	Glijbeugel compleet met knevelgreep en speciale drukplaat		Speciale drukplaat standaard		Speciale drukplaat gekarteld		Speciale drukplaat met prisma	
								
	Spandiepte mm	voor profiel mm	Spindelgat mm	Veerpen mm	Spindelgat mm	Veerpen mm	Spindelgat mm	Veerpen mm
TWM28	120	28 x 11	12	5 x 20	12	5 x 20	12	5 x 20
Bestelnr.	3101521		3100736		3101192		3101193	

Spanelement TW28GRS / TWVAD / TWA-STC / TW28AV

	Profiel		Grijparm compleet		Verlenging	
						
	Spanwijdte mm	Profiel mm	Spandiepte mm	voor profiel mm	Gat Ø mm	Aanpassingsbereik mm
TW28GRS	300	28 x 11	120	28 x 11		
Bestelnr.	3101706		3101590		-	
TWVAD TW16VAD TW16A-STC					16	15-200
Bestelnr.	-		-		TW16X	
TWVAD TW28VAD TW28A-STC TW28AV					28	15-300
Bestelnr.	-		-		TW28X	

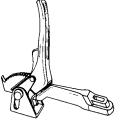
Machinetafelspanner BAS, BS, SGHS

	Drukarm	Drukschoen	Spindel	Glijbeugel compleet		Ver-grendelpal compleet
		 4 stuks	 2 stuks			 2 stuks
				Spandiepte mm	voor profiel mm	Bout-Ø x l mm
BAS...9-4						
Bestelnr.	3101428	3101431	3101726	-		-
BAS...10-6						
Bestelnr.	3101429	3101431	3101726	-		-
BSP...10-6						
Bestelnr.	3101430	-	3101726	-		-
BS2N / BS3N						5h11 x 26
Bestelnr.	-	-	-	-		3100747
BS4N						5h11 x 26
Bestelnr.	-	-	-	-		3100748
BS5N / BS6N SG-HS				140	30 x 15	
Bestelnr.	-	-	-	3101432		-

Lijst van accessoires en reserveonderdelen 2023/2024

Corpuslijmtangen KR/KRV/KRE/KREV

	Ondergedeelte compleet met glijbeugel		Set in zak	Tafelklem		Tafelklem		Tafelklem		Tafelklem	
	Span-diepte mm	voor profiel mm		Span-diepte mm	Span-diepte mm	Span-diepte mm	Span-diepte mm	Span-diepte mm	Span-diepte mm	Span-diepte mm	Span-diepte mm
			3 beschermkap 2 steunen 1 eindzekering	Ø 8 mm		Ø 8 mm		Ø 8 mm		Ø 8 mm	
KR...-2K KRV...-2K KRE...-2K KREV...-2K	95	29 x 9		60	22	60	28	100	50	150	50
Bestelnr.	3101774		3101775	TK6		RB269		LM10/5R8		LM15/5R8	

Corpuslijmtangen K/KR/KRV/KRE/KREV

	Verlenging	Variabel bovendeel		Adapter, zwenkbaar		Frameperset
		Spandiepte mm	voor profiel mm	Bek-hoogte mm	Bek-breedte mm	
				2 stuks /pak		4 stuks /pak
K...		95	29 x 9	-		
Bestelnr.	KBX20	KRE-VO		-		KP
KR...-2K KRV...-2K KRE...-2K KREV...-2K		95	29 x 9	170	25	
Bestelnr.	KBX20	KRE-VO		KR-AS		KP

Corpusspanner KS

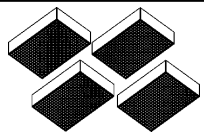
Drukstuk	
 <p>4 stuks /pak</p>	
KS	
Bestelnr.	3101845

Vlakkenspanner FK

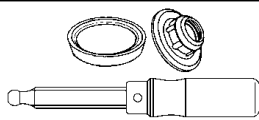
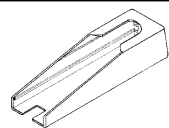
Spindel compleet met houten handgreep		Beschermkap
		 <p>2 stuks</p>
Trapeziumdraad mm		Spandiepte mm
FK16-8	-	80
Bestelnr.		3101790
FK...-10	16 x 4	100
Bestelnr.	3101386	3101789

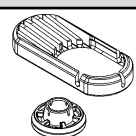

Schroefklem GearKlamp GK

Drukplaat + beschermkap in set	
 <p>5 paar</p>	
Ø mm	
GK	26
Bestelnr.	3101840

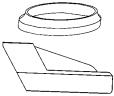
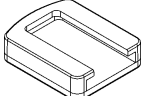

Eénhandsklemmen EHZ / EZS

	Beschermkap-set	Beschermkap-set
	 <p>5 paar</p> <p>Ø mm</p>	 <p>10 stuks</p> <p>mm</p>
EHZ...-2K	32	
Bestelnr.	3101402	—
EZS		40 x 48
Bestelnr.	—	3101841



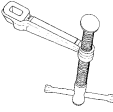
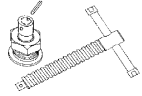
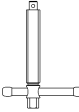
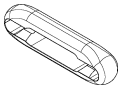

Eénhandsklemmen EZ

	Beschermkap-set	Klembevestiging
	 <p>10 stuks</p>	 <p>2 stuks</p>
EZM		
Bestelnr.	3101959	3101962
EZL		
Bestelnr.	3101960	—
EZXL		
Bestelnr.	3101961	—



Spantenlijmtang SPZ60K en SPZ80K

	Glijbeugel compleet	Combiset Spindel + speciale drukplaat + veerpin		Spindel		Knevelopzetstuk KA	Drukplaat met beschermkap
		 zonder zeskant		 met zeskant		 2 stuks	 4 paar
	voor profiel mm	Trapezium-draad mm	Knevel Ø x Lengte mm	Trapezium-draad mm	Knevel Ø x Lengte mm		
SPZ60K	27 x 13	18 x 5	10 x 120				
Bestelnr.	3101338	3100398		-		3101194*	3101188
SPZ80K	30 x 15	20 x 5	11 x 120	20 x 5	11 x 120		
Bestelnr.	3101330	3100399		3101815		-	-

Spantenlijmtang SPZ80K

	Speciale drukplaat standaard		Speciale drukplaat gekarteld		Speciale drukplaat met prisma		Snijring	
								
	Spindelgat mm	Veerpen mm	Spindelgat mm	Veerpen mm	Spindelgat mm	Veerpen mm	Spindelgat mm	Veerpen mm
SPZ80K	12	5 x 20	12	5 x 20	12	5 x 20	12	5 x 20
Bestelnr.	3100736		3101192		3101193		3101219*	

Griptangen GRZ

	Beschermkap voor GRZ10 en GRZ20	Beschermkap voor GRZRO
	 4 stuks	 2 paar
GRZ 10 - GRZ 20		
Bestelnr.	3100576	—
GRZRO		
Bestelnr.	—	3101547

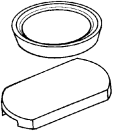

KliKlamp KLI

	Beschermkap voor bovenste en onderste deel	
	 10 paar	
	voor Ø mm	voor breedte onderste deel mm
KLI	25,5	23
Bestelnr.	3101393	

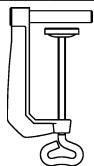
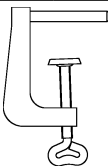
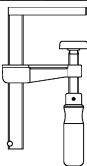
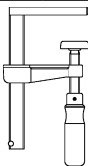
Schroefspanner S 10 / Hoekspanner WS

	Tafelklem		Tafelklem		Tafelklem		Tafelklem	
								
	Ø 8 mm		Ø 8 mm		Ø 8 mm		Ø 8 mm	
	Span-wijde mm	Span- diepte mm	Span- wijde mm	Span- diepte mm	Span- wijde mm	Span- diepte mm	Span- wijde mm	Span- diepte mm
S10-ST / WS 3	60	22	60	28	100	50	150	50
Bestelnr.	TK6		RB269		LM10/5R8		LM15/5R8	

Eénhands tafelklem EZR

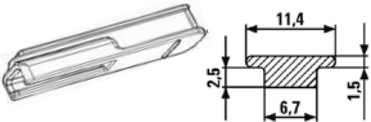
	Beschermkap-set	Klembevestiging	Adapter voor geleiderails (Bosch, Mafell)
			
	10 stuks	2 stuks	2 stuks
EZR			
Bestelnr.	3101959	3101962	3102016

KliKlomp KLI

	Beschermkap voor bovenste en onderste deel	
		
	10 paar	
	voor Ø mm	voor breedte onderste deel mm
KLI	22	17
Bestelnr.	3101391	

Bandspanner BAN

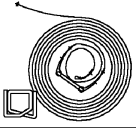
Band reserveonderdeel/verlenging	
	
BAN 700 / SVH	Band 7100 mm, 2 spangespen
Bestelnr.	3100832

Eénhands-kantenlijmtang EKT

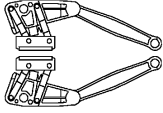
	Reserveset	Bekken compleet met koppelstang
		
	3 stuks beschermkappen en 6 stuks drubbekken	2 paar
EKT55		
Bestelnr.	3101403	3100998

Kantenlijmtang KT

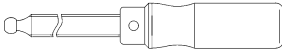
Spindel compleet	
	
KT5-1	
Bestelnr.	3101799

Kantenfix KF en platendrager KFP

Drukbekken	
 <p>1 paar incl. veer</p>	
KF2	
Bestelnr.	4102100
KF4	
Bestelnr.	4102056
KFP	
Bestelnr.	4102057*

* geschikt voor KFP vanaf 2018 (rode drubbekken)

Platenspanner PS

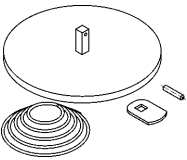
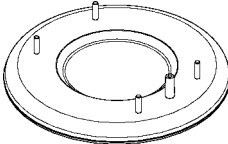
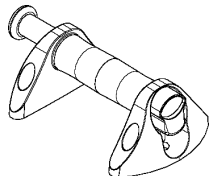

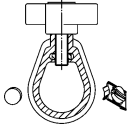

		Zuigklem	Rubberplaat	Greep
				
		Ø mm	Ø mm	
PS 55		120		
Bestelnr.	3101839		-	-
PS 130			210	
Bestelnr.	-		3101685	3101686

Lijst van accessoires en reserveonderdelen 2023/2024

Kozijnspanner TMS

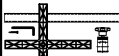
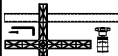
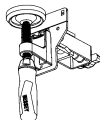
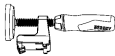
	Klemstuk
	
TMS	
Bestelnr.	3100983

Kozijnspanner TU

	Drukplaat met binnenbuis en klemstuk compleet	Drukplaat met buitenbuis en klemstuk compleet	Spanbeugel breed compleet incl. schuifdeel	Spanklem compleet	Verlenging	Viltstrepen	TU tas
							
		Binnenmaat mm				4 stuks	
TU		25 x 25					
Bestelnr.	3100934	3100935	3101752	3101764	TUX	3101632	3101762

Kozijnuitlijnklem TFM

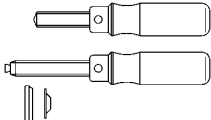
	2 x Spindel met drukplaat en beschermkap
	
TFM	
Bestelnr.	3101408

Vensteruitlijnklem FRK

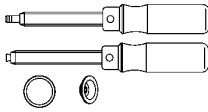
2 x Spindel met drukplaat en beschermkap	
	
FRK	
Bestelnr.	3101409

Deurenspanner TAN

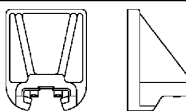
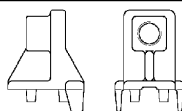
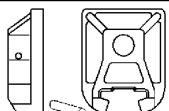
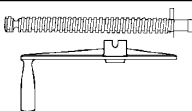
	Drukbecken		Spindelhouder	Spanbecken	Spindelset TAN
					
	Bekbreedte mm	Bekhoogte mm	Trapezium-draad mm		
TAN	75	80	20 x 5		
Bestelnr.	3101791*		3101824*	3100919*	3101404*

Deurenspanner TB

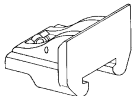
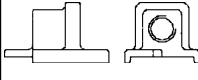
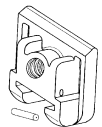
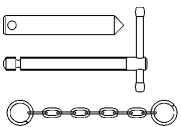
	Drukbecken		Spindelhouder	Spanbecken	Spindelset TB
					
	Bekbreedte mm	Bekhoogte mm	Trapezium-draad mm		
TB	60 (80)	48	18 x 5		
Bestelnr.	3101793		3101792	3100920	3101405

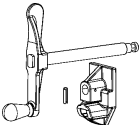
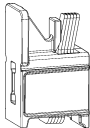

Deurenspanner TL

	Spindelset compleet	Drukbecken compleet
		
TL		
Bestelnr.	3101876	3101877

Plafond- en montagesteunen STE, ST

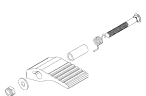

	Multifunctionele-/ laserhouder	Steunplaat	Plafondstempel	Bouwstempel	Combitas
					
STE					
Bestelnr.	STE-LH	STE-SP35	STE-DS	STE-BS	–
ST					
Bestelnr.	STE-LH	STE-SP35	STE-DS	STE-BS	–
STE300 STE370					
Bestelnr.	–	–	–	–	STE-BAG

Plafond- en montagesteunen STE, ST

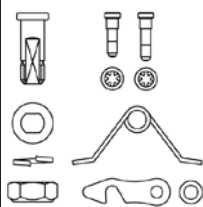
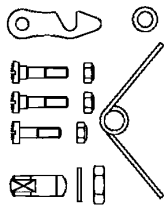
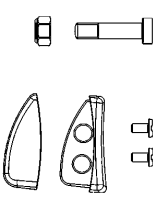

	Contactvlak ver- vangingsonderdeel	Vergrendelingslip	Stergreepschroef
			 4 stuks
STE			
Bestelnr.	3101952	–	–
ST			
Bestelnr.	3101952	3101969	–
STE-SP35			
Bestelnr.	–	–	3101970

Lijst van accessoires en reserveonderdelen 2023/2024

Blikscharen met hefboomoverbrenging

	Reparatieset 08/22A 27/29/123S	Reparatieset 17A-2	Laaghouder compleet 123S	Roltas
				 voor 3 scharen
D08 ... D16A D22A D27AH-TiN/L				
Bestelnr.	R032	-	-	7002464
D16 / D16L / D16S				
Bestelnr.	-	-	-	7002464
D27 ... D29 ...				
Bestelnr.	R001	-	-	7002464
D17A-2/L				
Bestelnr.	-	R043	-	7002464
D123S				
Bestelnr.	R001	-	R042	7002464

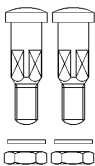
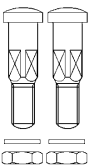
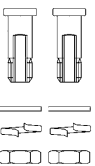
Standaard blikscharen

	Verschroeving compleet M6 D8 x 24	Verschroeving compleet M6 D8 x 26	Verschroeving compleet M8 x1 x 22	Roltas
	 <p>2 stuks</p>	 <p>2 stuks</p>	 <p>2 stuks</p>	 <p>voor 3 scharen</p>
D101-200 – D101-250 D201-200 – D201-250 D102-225 D202-225 D107-225 – D107-275 D207-225 – D207-275 D114-250 – D114-275 D214-250 – D214-275 D159-200 – D159-250				
Bestelnr.	R034	–	–	7002464
D102-250 – D102-300 D202-250 – D202-300 D106-250 D106A-250 D107-300 – D107-350 D207-300 – D207-350 D208-275 D209-275 D114-300 D214-300 D159-300 – D159-350				
Bestelnr.	–	R035	–	7002464
D116-260 – D116-280 D216-260 – D216-280 D216-260-B-SBSK D216-280-B-SBSK D118-300 – D118-350 D218-300 – D218-350 D416-280 D 418-300 – D418-350				
Bestelnr.	–	–	R036	7002464
D407-275 – D407-300				
Bestelnr.	–	–	–	7002464

Knabbelscharen

	Vervangmes
	
D24	
Bestelnr.	D241

Knipmessen

	Stanleymessen	Tapijtmessen	Uitsnijmessen
			
	10 stuks	10 stuks	5 stuks
DBKPH DBKWH DBKAH			
Bestelnr.	DBK-T	DBK-H	DBK-L



Gewoon beter.



Gewoon beter.



lijst-van-accessoires-en-reserveonderdelen__nl
01/2024 „n”

www.bessey.de

BESSEY Tool GmbH &Co. KG ■ Mühlwiesenstraße 40
74321 Bietigheim-Bissingen, Germany
Fon +49 7142 401-0 ■ Fax: +49 7142 401-452
E-Mail: tool-info@bessey.de